



MS58-2020D13M4

5.8GHz Radar Sensor Module Data Sheet

MS58-2020D13M4 is a miniaturized 5.8GHz radar sensor module launched by MoreSense.

Revision History

Version	Description	Release Date
V1.0	Initial Version	2022-11-22

MoreSense

Catalog

1 Product Description	1
2 Product Feature	2
3 Key Application	3
4 Module Parameter	4
5 Pin Definition	5
6 Module Dimension	5
7 Name Rules	6
8 Operation Guideline	7
8.1 Module Out RAM Timings	7
8.2 Induction Range	7
9 Precautions	8
10 Customation	9
11 Hardware Typical Application	9

1 Product Description

MS58-2020D13M4 is a miniaturized 5.8GHz radar sensor module launched by MoreSense. This module uses high-performance radar sensors combined with miniaturized planar antennas to achieve a size of 20 x 20mm while ensuring the performance of the sensor.

The sensor can detect that if there have the moving objects in the region by frequent difference between the transmit and receive signals (Doppler Principle) or high-frequency electromagnetic waves.

The sensor is not affected by ambient temperature, humidity, airflow, dust, noise, brightness and so on. With a built-in multi-filter algorithm, the module has a strong anti-jamming capability and its signal can penetrate glass, acrylic and other non-metallic materials. The sensor can be used to detect various scenes of human being or moving target sensing, including smart home, smart lock and so on, Especially in the field of night light, solar street light and wireless cameras.

The module comes with default parameters from the factory, and you can also flexibly modify the attributes of the module through serial port commands or set the module gear by configuring the pin level.

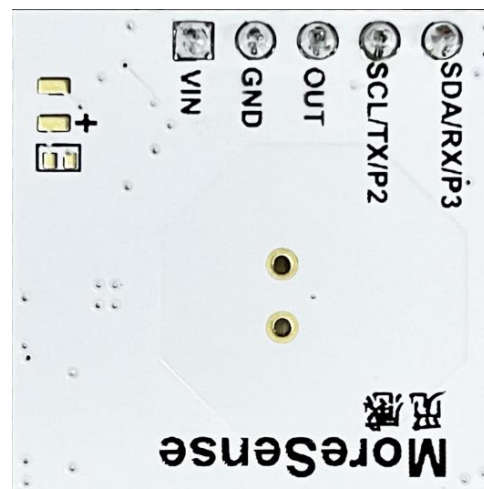
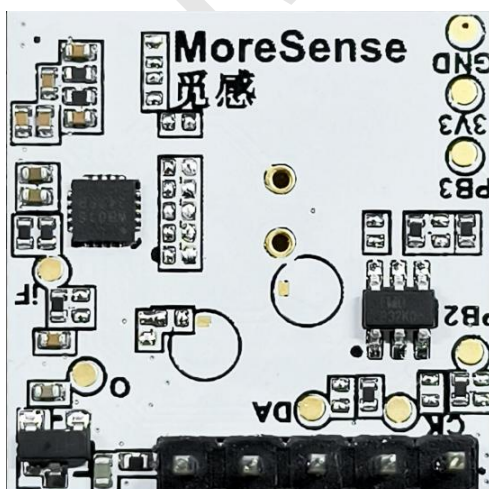

2 Product Feature

- ★ Working Frequency: 5.8G ISM frequency band;
- ★ Microwave radar sensor based on Doppler effect;
- ★ Sensing distance and delay time can be adjusted flexibly according to different application;
- ★ Using mature CMOS technology to achieve fully integration of ultra-cost-effective;
- ★ The chip has a built-in LDO that supports wide-voltage power supply;
- ★ Support standard UART or I2C interface, which can be interconnected with other MCU or sensors;
- ★ Support two working modes of normal power consumption and ultra-low power consumption;
- ★ Meet the certification standards such as FCC, RED, CE and ETL;

3 Application

This module can be used for smart door locks, low-power IPCs, night lights and other products and scenarios that require automatic sensing such as smart lighting, smart home, energy saving, courtyards, and security monitoring.



Smart Lock



Cabinet Light



Intelligent Toilet



Intelligent Lighting



Parking Space Detection



Smart Home

4 Module Parameter

Type	Parameter	Value
RF Parameter	Certification Standards	FCC/CE/SRRC/RoHS
	Frequency Range	5.725GHz~5.875GHz
	Transmit Power	-4dBm
	Antenna	Built-in;Flat Antenna
Hardware Parameter	Data Interface	GPIO
	Operating Voltage	2.5-4.8/5-12V(LDO version)
	Operating Current	13mA
	Operating Temperature	-20°C- 85°C
	Storage Temperature	-40°C- 150°C
	Humidity	<85%
	Dimension	20mmx20mm
Default Parameter	Power-On Self-Test Time	2s
	Sensing Output Level	3.3V
	Silent Output Level	0V
	Sensing Output Time	2s
	Inducting Distance	Radius about 5-6m
	Customizing the Largest Sensing Distance	12m
	Max. Induction Radius with Hanging Height 3m	6m
Hand Scanning Distance	Within 30cm	
	Setting Parameter Method	UART /IO Setting Parameter

5 Pin Definition

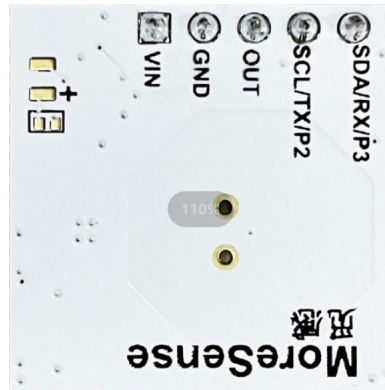
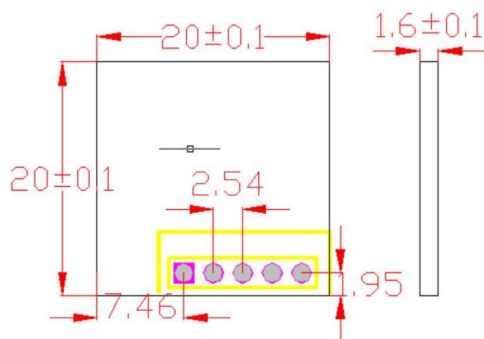

Table 1. MS58-2020D13M4 Pin Function Definition

Pin	Name	Type	Description
1	VCC		Power Supply
2	GND		Ground
3	OUT	0	Signal Output
4	SCL/TX/P2	I/O	
5	SDA/RX/P3	I/O	

Note: I:Input O:Out T:High impedance state

6 Module Dimension



Unit: Millimeter (mm)

7 Name Rule

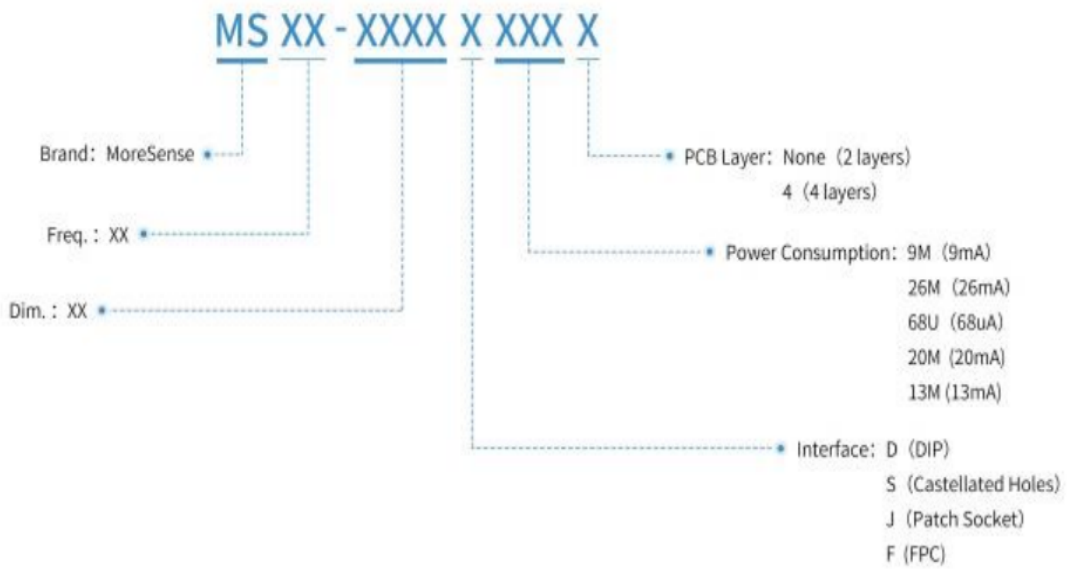

④ Interface

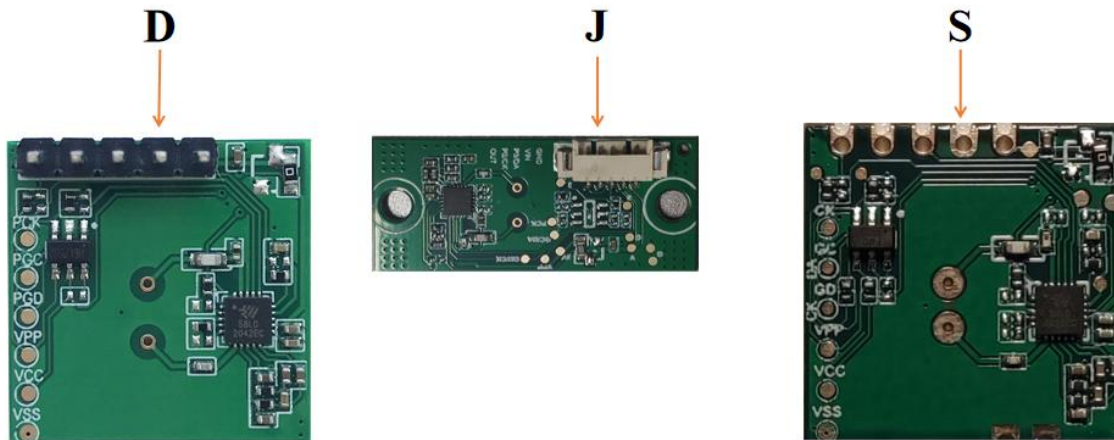

8 Operation Guideline

8.1 Module OUT RAM Timings

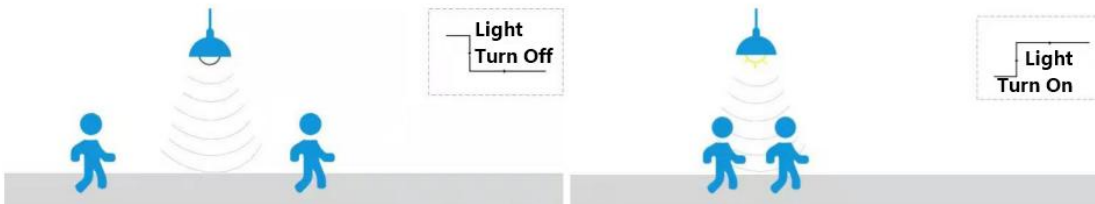
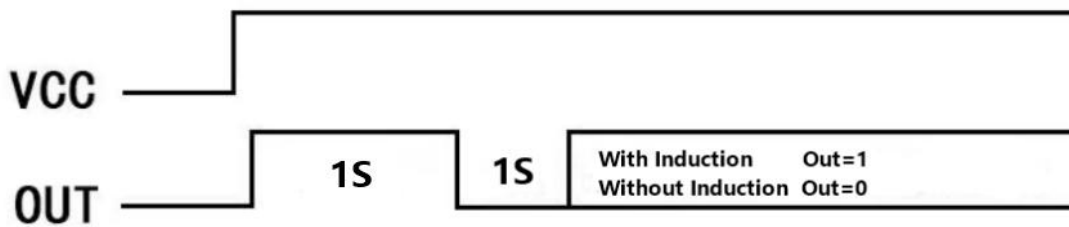

8.2 Induction Range

The sensing sensitivity of radar sensor can be configured by MCU. The actual sensing distance can be adjusted according to the needs. The above is the schematic diagram of radar detection range in case of high hanging. If the sensitivity is set higher, the detection range will be correspondingly larger. In the figure, the dark area is the high sensitivity area that the object can be fully detected, while the light area is the low sensitivity area that the object can be detected basically. The actual product structure and assembling environment also affect the distance and angle of radar detection.

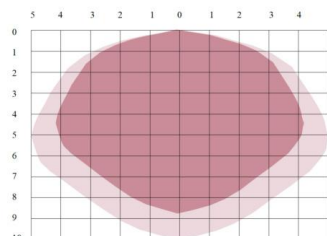

9 Precautions



Try to avoid placing the radar antenna in the direction of large metal equipment or pipes,etc.

The front of the antenna should be installed without a metal shell or components to avoid shielding the signal.

The power frequency will interfere with the radar signals.During installation,it should avoid forwarding the AC drive power supply,staying away from AC power lines,rectifier bridges and other lines.

Covers such as glass,acrylic,or plastic are allowed,but there should be a proper clearance area in front of the antenna,and a minimum spacing of 5mm or more is recommended.

During installing multiple radar modules,please try to ensure that the antennas of each radar module are parallel to each other,avoiding positive irradiation between the antennas,and to maintain more than 1 m of space between the modules.

The power supply power supply driver capability of the radar module needs to be greater than 50mA,otherwise the sensor will be abnormal.

10 Customization

Power Supply Voltage	Sensing Out Method	Setting Parameter	Supplement
<input checked="" type="checkbox"/> 3.3V	<input checked="" type="checkbox"/> IO Out (Reverse Supported)	<input checked="" type="checkbox"/> IO Setting Para.	<input type="checkbox"/> Light Sensor
<input checked="" type="checkbox"/> 5V	<input checked="" type="checkbox"/> UART	<input checked="" type="checkbox"/> UART	<input type="checkbox"/> Power Management Function
<input checked="" type="checkbox"/> 12V	<input type="checkbox"/> PWM	<input type="checkbox"/> IIC	—
<input type="checkbox"/> 24V	—	—	—

: Supporting : Supported

11 Hardware Typical Application

