



User Manual

TracX-1b

4G/GNSS Modem

About Copyright

©2023 Vanix Technologies Pvt. Ltd. All rights reserved.

Trademark

Each of the trademarks herein is registered. The name of this product and other trademarks mentioned in this manual are the registered trademark of their respective company.

Restriction

Copyright of this document is reserved. Under no circumstances, this document shall be reproduced, distributed or changed, partially or wholly, without formal authorization.

Disclaimer

Vanix Technologies does the best to verify the integrity and correctness of the contents in this document, but no formal guarantee shall be provided. Use of this document and the subsequent results shall be entirely on the user's own responsibility. Vanix Technologies reserves the right to change the contents of this document without prior notice.

Document Version: UserManual-TracX-1b - 1.3

Last updated on: 25 April 2024

Revisions: 4 Feb 2024



Contents

1. Introduction.....	4
2. Product Overview.....	5
3. Technical Specifications.....	6
4. Application Interfaces.....	8
4.1 Pin Description.....	8
4.2 Hardware Interfaces.....	9
4.3 Antenna Interfaces.....	11
5. Mechanical Dimensions.....	12
6. Integration and Interface Guide.....	13
6.1 Connecting to Systems with RS232, RS485, or UART.....	13
6.2 Connecting Displays Using I2C.....	14
6.3 Connecting Sensors.....	15
7. USB Modem Driver Installation.....	17



1. Introduction

Welcome to Vanix TracX-1b Modem series, an advanced and versatile communication device incorporating the Quectel EC200U-CN series module. This modem is expertly designed to serve as a high-performance GPS tracker and an autonomous controller for Machine to Machine (M2M) and Internet of Things (IoT) applications. The Vanix 4G/GNSS Modem is adept at functioning in a multitude of environments, including automotive, metering, and security systems. It has been engineered to efficiently handle various interfaces and sensors, making it a robust and adaptable solution for a wide array of applications.

The modem's design ensures seamless compatibility with diverse systems and is characterized by its minimal system requirements. To operate, it simply requires a power source, antennas, and a SIM card for its cellular functionalities. This manual provides technical details for users to effectively utilize the Vanix 4G/GNSS Modem for multiple applications.

Key Features:

- **High-Speed Data Connectivity:** TracX-1b series modems offer 4G LTE technology for fast data transfer speeds, making it suitable for applications that require real-time data transmission.
- **Wide Network Coverage:** TracX-1b series modems offer stable connection and broad coverage using 4G network infrastructure, ensuring connectivity in various locations.
- **Compact Size:** TracX-1b series modems are available in compact form factors, making them suitable for integration into small and portable devices.
- **Versatility:** TracX-1b series modems can be integrated into a wide range of devices, including embedded systems, consumer electronics, and industrial equipment.
- **Hybrid Triangulation:** TracX-1b series modems ensure to provide location information even when GPS/GNSS Signals are not present; using hybrid Triangulation methods using Quectel and Wifi Scans.



2. Product Overview

The Vanix **TracX-1b** encapsulates the cutting-edge capabilities of the EC200U-CN module, offering unparalleled connectivity with LTE-FDD, LTE-TDD, GSM and GNSS. The Vanix Modem is a promising solution for individuals and organisations looking for reliable location or data transfer capabilities with their products. Some of the potential use cases are discussed below:

Use Cases:

- **IoT Devices:** TracX-1b series modems can be commonly used in IoT applications, such as smart metres, asset tracking, and remote sensors, to provide these devices with data transfer capabilities.
- **Wireless Routers:** TracX-1b series modems can be integrated into portable routers and mobile hotspots to create Wi-Fi networks wherever a cellular signal is available.
- **Automotive Telematics:** TracX-1b series modems can be used in vehicles for services like GPS navigation, vehicle diagnostics, and in-car entertainment systems.
- **Point-of-Sale (POS) Systems:** Mobile POS systems can use TracX-1b series modems for wireless payment processing and data communication.
- **Remote Monitoring and Control:** Industrial and infrastructure applications, such as remote monitoring of equipment or control systems, can use TracX-1b series modems to transmit data over long distances.



3. Technical Specifications

The heart of TracX-1b is the EC200U-CN LTE Cat 1 module, renowned for its robust performance and reliability. It supported a wide range of network data connections including LTE-FDD, LTE-TDD, and GSM/GPRS. Designed to be incredibly versatile, the EC200U series caters to a plethora of Machine-to-Machine (M2M) applications. Whether it's for use in automotive technology, metering systems, tracking mechanisms, security setups, routers, wireless POS systems, or mobile computing devices like PDAs and tablet PCs, this module adapts effortlessly to your specific needs.

3.1 TracX-1b Key Technical Features

Table 1:

Features	Details
Power Supply	<ul style="list-style-type: none">→ Supply Voltage (Vbat): 3.7V - 4V→ USB-C: 3.7V - 5V→ Typical Supply Voltage: 3.8V
LTE Features	<ul style="list-style-type: none">→ Support CAT 1 FDD & TDD→ Max 10 Mbps (DL) Max 5 Mbps (UL)
GSM Features	<ul style="list-style-type: none">→ Support GPRS multi-slot class 12→ Coding Scheme: CS-1, CS-2, CS-3 & CS-4→ Max 85.6 Kbps (DL) Max 85.6 Kbps (UL)
Internet Protocol	<ul style="list-style-type: none">→ Support: TCP/UDP/PPP/NTP/NITZ/FTP/HTTP/PING/CMUX/HT TPS/ FTPS/SSL/FILE/MQTT/MMS protocols
SMS	<ul style="list-style-type: none">→ Text and PDU mode→ Point to point MO and MT→ SMS cell broadcast
SIM Interface	<ul style="list-style-type: none">→ Support nano SIM card
UART Interface	<ul style="list-style-type: none">→ For AT communication & data Transmission→ Baud rates up to 921600 bps; 115200 bps by Default→ Support MAIN_RTS & MAIN_CTS Hw flow control
AT Commands	<ul style="list-style-type: none">→ Compliant with 3 GPP TS 27.007, 27.005 and Quectel enhanced AT command
Antenna Interfaces	<ul style="list-style-type: none">→ Main antenna interface (ANT_MAIN)→ GNSS antenna interface (ANT_GNSS)
Physical Dimension	<ul style="list-style-type: none">→ 37.97mm x 55.7mm x 4mm
Temperature Ranges	<ul style="list-style-type: none">→ Operation temperature range: -35 °C to +75 °C



Features	Details
Power Supply	<ul style="list-style-type: none"> → Supply Voltage (Vbat): 3.7V - 4V → USB-C: 3.7V - 5V → Typical Supply Voltage: 3.8V
LTE Features	<ul style="list-style-type: none"> → Support CAT 1 FDD & TDD → Max 10 Mbps (DL) Max 5 Mbps (UL)
	<ul style="list-style-type: none"> → Storage temperature range: -40 °C to +90 °C

3.2 Frequency Bands of EC200U-CN Module

Table 2:

Network Mode	EC200U-CN
LTE-FDD	B1/B3/B5/B8
LTE-TDD	B34/B38/B39/B40/B41
GSM	900 MHz/1800 MHz
GNSS	GPS/GLONASS/BeiDou/Galileo/QZSS



4. Application Interfaces

4.1 Pin Description

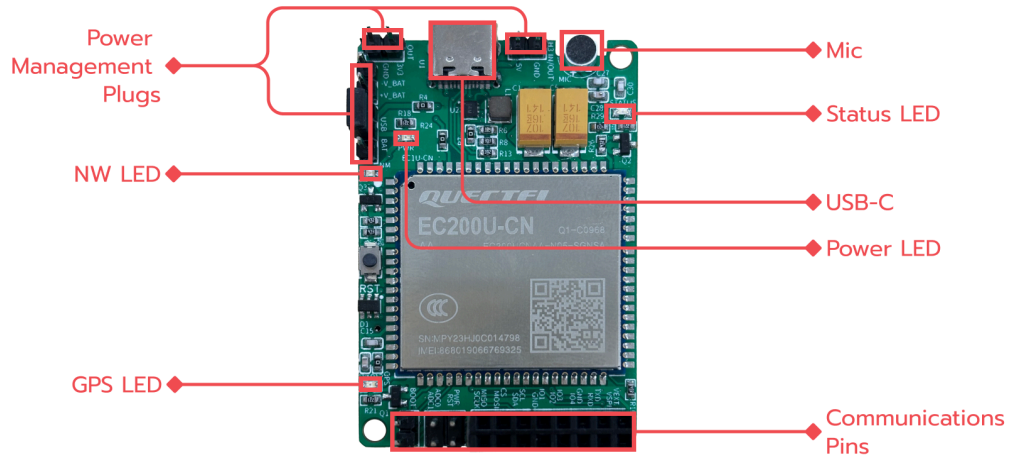

Fig 1: Key Components

Table 3:

Communication Pins	Function
UART Pins	Tx - Transmitter pin of UART Port
	Rx - Receiver pin of UART Port
	GND
SPI Pins	MISO, MOSI, SCK
I2C Pins	SDA - Serial Data
	SCL - Serial Clock
ADC Pins	ADC0, ADC1
GPIO1	IO1
GPIO2	IO2
GPIO3	IO3
GPIO4	IO4

4.2 Powering ON the device

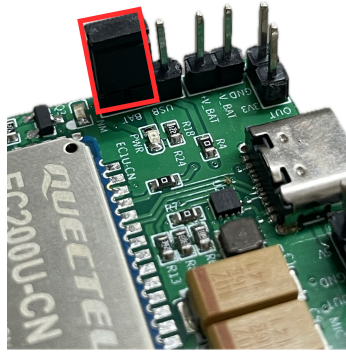

Fig 2

*Please note that when a pre-charged battery is connected between +V_BAT and -V_BAT, the position of the jumper on the board should be connected between BAT (square pad) to power ON the device as shown in Fig 2.

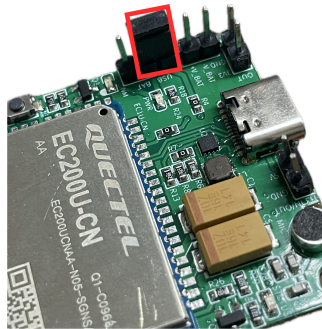
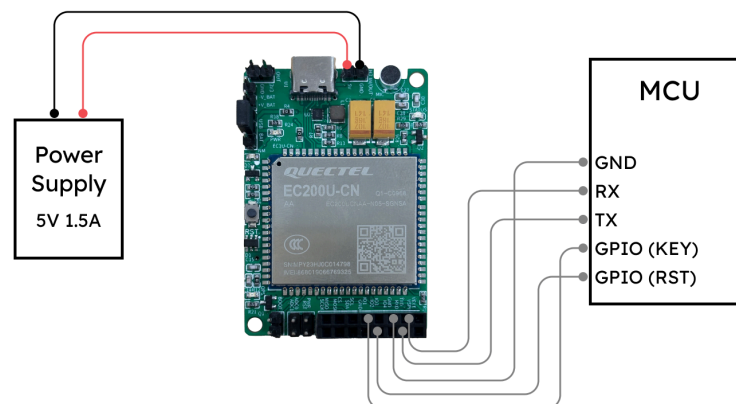

Fig 3.

*Please note that when the device is being Powered ON using the USB connected to PC/Laptop the jumper on the board should be connected between USB (square pad) as shown in Fig 3.

4.3 Hardware Interfaces



4.3.1 Control Signals

- **PWRKEY:** When TracX-1b Modem is in power down mode, it can be turned on to normal mode by driving the PWRKEY pin to a low level for at least 2 s. When the supply is connected initially the modem is turned on by default without applying any pulse to the PWRKEY pin.
- **Turn off Module:** The following procedures can be used to turn off the module
 - Turn off the module using PWRKEY pin - Driving the PWRKEY pin to a low level voltage for at least 3s, the Modem will execute power-down procedure after the PWRKEY is released
 - Turn off the module using AT+QPOWD command - It is also a safe way to use AT+QPOWD command to turn off the Modem, which is similar to the procedure of turning off the module via PWRKEY pin.
- **RST - Reset the Module:** The RST pin can be used to reset the Modem. The Modem can be reset by applying low Pulse to the RST pin for at least 100 ms and then releasing it.

4.3.2 USB Interface

TracX-1b 4G Modem contains one integrated Universal Serial Bus (USB) interface which complies with the USB C specification and supports high-speed (480 Mbps) and full-speed (12 Mbps) modes. The USB interface only supports USB slave mode. This interface is used for AT command communication, data transmission, software debugging, firmware upgrade and voice over USB.

4.3.3 SIM Card Holder

The Nano SIM card Holder connects with the EC200 Module. The EC200 module uses the SIM card with the different functions: SMS, Phone Calls & Internet. Sim card orientation:

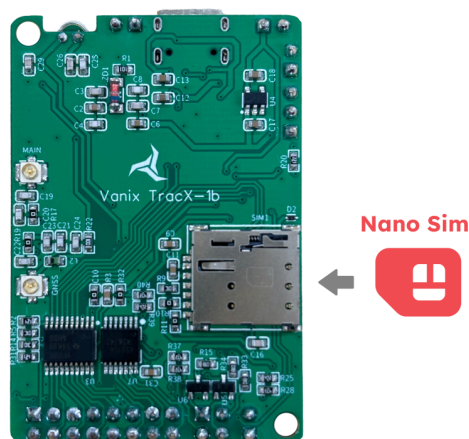

4.3.4 LED Status Indication

The modem is equipped with three distinct LEDs that provide visual indicators for the network status, GPS functionality, and overall modem operational status.

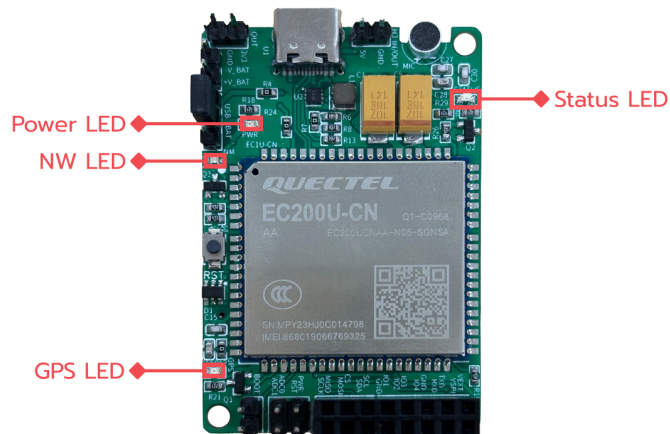

- **Network Mode Status (NM LED):**
 - The NM LED on the modem provides visual feedback on the network connection status.
 - Flicker Slowly: Indicates that the modem is in network searching mode (200 ms on, 1800 ms off).
 - Flicker Quickly: Signifies that the modem is registered on the LTE network (234 ms on, 266 ms off).
- **GPS Status (GPS LED):**
 - Indicates the operational status of the GPS functionality.
- **Operational Status (STATUS LED):**
 - When the modem is powered and functioning normally, the STATUS LED will be on.

*Note: LED behaviours can be customised and reprogrammed to suit different operational requirements.

4.4 Antenna Interfaces

TracX-1b 4G LTE Modem antenna interfaces include a main antenna interface connector, a GPS/GNSS antenna ufl interfaces connector which is used to resist the fall of signals caused by high speed movement and multipath effect. The antenna connectors have an impedance of 50 Ω.

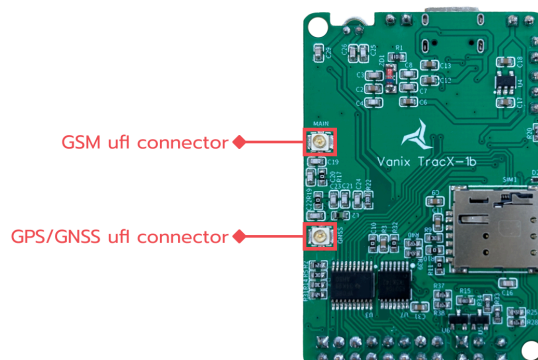

5. Mechanical Dimensions

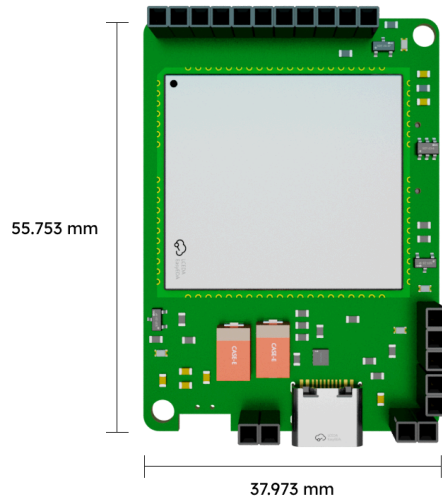

6. Integration and Interface Guide

This section offers a concise guide for seamlessly integrating various external peripheral devices, such as LCDs, sensors, and other serial interfaces, with the TracX-1b module. It provides clear instructions on pin-to-pin connections and the utilisation of communication protocols such as UART and I2C ensuring a straightforward integration process.

6.1 Connecting to Systems with RS232 via UART

This section is dedicated to explaining how users can connect the TracX-1b module to a PC or laptops. In general, a RS232 port is used to communicate via the serial i.e. UART protocol interface available on the Module. This UART is a serial communication protocol that is widely used in industrial and networking applications, providing reliable data transfer at ease.

Fig.8 diagram illustrates a typical setup where the TracX-1b modem is interfaced with an RS232 controller. Here, a MAX232 based transceiver is utilized as an intermediary to match the voltage levels between the TracX-1b's TTL outputs and the RS232 of external devices. The MAX232 or similar systems convert the TIA-232 (RS232) input signals into TTL/CMOS output levels that are suitable for the module and vice versa, thus enabling a seamless communication channel.

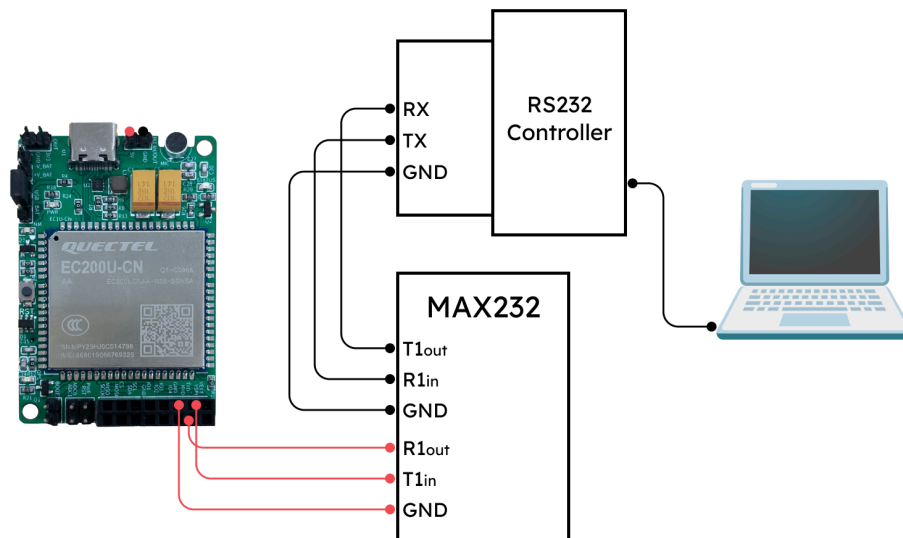

Basic Connection Steps:

- **Port Identification:**
 - Begin by identifying the RS232, or UART port on your target system.
 - Obtain a suitable cable that matches the port specifications.
 - On the TracX-1b module, locate the UART pins designated as Tx (Transmit), Rx (Receive), and GND (Ground).



- **Communication Configuration:**
 - Configure the modem to match the communication parameters of your system. This involves setting the baud rate, parity, number of data bits, and stop bits to align with your system's protocol.
 - This parameter tuning is critical for error-free data transfer and will ensure the integrity of the information being communicated.
- **Power Supply and Grounding:**
 - Ensure that the modem is powered with the correct voltage levels as specified for your model (refer *Technical Specification* section).
 - Proper grounding is crucial to mitigate the effects of electrical noise and interference which can severely impact communication quality. A stable ground connection maintains signal integrity across the connected systems.
- **Practical Implementation Tips:**
 - For UART connections, ensure that the logic level of the device matches that of the modem. If not, employ logic level converters.
 - Always follow electrostatic discharge (ESD) precautions when handling the modem and connecting cables to prevent damage to sensitive electronic components.

Further Guidance: For detailed instructions, including wiring diagrams, configuration settings and custom applications, please reach out to our support team.

6.2 Connecting Displays Using I2C

This subsection guides users on interfacing displays with the modem using the I2C protocol, a popular choice for connecting low-speed peripherals like LCDs.

- **I2C Interface Preparation:** Locate the SDA and SCL pins on the modem for I2C communication. Verify that the voltage levels of these pins are compatible with your display. If they differ, use a logic level converter to match the display's required logic levels.
- **Display Module Setup:** Configure the display module with the correct I2C address and initiate display parameters based on its datasheet. Different displays will have distinct command sets which necessitate specific driver logic in the modem's firmware for operation.
- **Driver Logic Accommodation:** Embed the appropriate driver logic for the display into the modem's firmware. This ensures the I2C commands from the modem are accurately interpreted by the display module.
- **Protocol Synchronization:** Observe the protocol used for communication between external devices & TracX-1b module and make sure to use the same protocol. In the case of I2C master (the module) and the slave (the display) follow the same I2C protocol standards.

For further technical support, including integration schematics and compatible driver libraries, please contact Vanix Technologies.



6.3 Connecting Sensors

This section outlines the procedures for integrating a variety of sensors using the module's I2C interface. This enables functionalities such as temperature monitoring, motion detection, and more.

Integration Steps:

- **Pinout Identification:** First, identify the appropriate protocol pins (I2C) for your sensor. Ensure these pins are configured correctly as per the protocol mentioned on the sensor.
- **Sensor Connection:** For both digital and analog sensors, follow standard wiring practices such as Pull-up and Pull-down resistances. Utilizing Pull-up/Pull-down Resistors: Employ these resistors wherever necessary to ensure stable voltage/signal levels and reliable sensor readings.

Example: Interfacing a Temperature Humidity Sensor (SHT40):

The SHT40 operates at 3.3V using the I2C protocol. A typical procedure to connect is discussed below:

1. Connect the sensor's VCC to the 3.3V pin on the module.
2. Connect the sensor's GND to a GND pin on the module.
3. Connect the SCL and SDA pins of the sensor to the corresponding I2C pins on the module.
4. Implement code to retrieve sensor data for use in applications like cloud services, LCD units, or RS232/RS485 interfaces.

For advanced sensor integration, please contact Vanix Technologies.

6.4 Comprehensive Assistance:

For in-depth support with software and firmware, including tailored solutions and troubleshooting, please feel free to reach out to us. Our team is equipped to help you build and optimize your applications, leveraging the full range of functionalities offered by the modem.



7. USB Modem Driver Installation

Follow these step-by-step instructions to install the EC200U-CN USB Modem Driver on your laptop or PC.

Driver Installation Process:

- **Download and Extract the Driver:**
 - Download the EC200U-CN LTE 4G GNSS USB Modem Driver. (Link: https://drive.google.com/drive/folders/1nNj2oWpeet4LB5JiDcvFceP1GUiq4p-t?usp=drive_link)
 - Extract the downloaded file to a suitable location on your computer & install the setup
- **Connect the Modem:**
 - Plug the TracX-1b EC200U-CN USB Modem into a USB port on your laptop or PC.
- **Device Detection:**
 - Open the Device Manager on your computer.
 - The modem should now be detected.
- **Update Driver:**
 - Right-click on “Mobile Generic Serial” in the Device Manager.
 - Select ‘Update driver’.
- **Driver Location:**
 - Choose ‘Browse my computer for drivers’.
 - Navigate to the folder where you extracted the driver in step 1 and select it.
- **Driver Installation:**
 - Click ‘Next’ to begin the installation of the Quectel USB MOS Port driver.
- **Install Remaining Drivers:**
 - Repeat the above steps for each driver that needs installation.
- **Completion:**
 - Once all drivers are installed, your Device Manager should display all the components correctly.



Thanks!

Address: T-hub, Inorbit Mall Rd, Vittal Rao Nagar,
Madhapur, Hyderabad, Telangana - 500081

Visit us at vanixtechnologies.com
Contact: +91 95156 01706
Email: sales@vanix.in, info@vanix.in

