

SPECIFICATION OF LCD MODULE

CUSTOMER 客户名称	
PART NO. 产品型号	JHD754B FP/W 1.0
PRODUCTS TYPE 产品内容	
REMARKS 备注	
SIGNATURE BY CUSTOMER 客户签署:	

		
---	--	--

LCM System

① LCD Type

 STN FSTN DFSTN

② Viewing Angle

 Lower 6:00 Upper 12:00 Others

③ Display Mode

 Yellow Green positive Blue Negative Grey positive FSTN positive FSTN negative

④ Polarizer Mode

 Reflective Transflective Transmissive

⑤ Connector

 Pin Heat sealed FPC

⑥ Thickness of Glass

 1.1mm 0.4mm 0.55mm 0.7mm

⑦ Backlight Mode:

 LED CCFL

⑧ Backlight Color

 Blue Amber Yellow Green Red White Without backlight

⑨ Temperature Grade

 Normal temperature Wide temperature Super wide temperature

CONTENTS

1.	FEATURES	5
2.	MECHANICAL DATA	5
3.	ABSOLUTE MAXIMUM RATING	6
4.	ELECTRICAL CHARACTERISTICS	6
5.	ELECTRO-OPTICAL CHARACTERISTICS	8
6.	BLOCK DIAGRAM	9
7.	TIMIING DIAGRAM	10
8.	INSTRUCTION SET	13
9.	INITIALIZATION SEQUENCE	14
10.	OUTLINE DRAWING	15
11.	INTERFACE	17
12.	QC/QA PROCEDURE	18
13.	RELIABILITY	19
14.	HANDING PRECAUTIONS.....	20

1. FEATURES

•Display construction.....	128*64 DOTS
•Display mode.....	FSTN
•Display type.....	Positive Transflective
•Backlight.....	LED/3.1V(White)
•Viewing direction.....	6 o'clock
•Operating temperature.....	-20 to 70 °C
•Storage temperature	-30 to 80°C
•Driving voltage.....	Single power
•Driving method.....	1/65 duty, 1/9 bias
•Type.....	COG (Chip On GLASS)
•Drive IC.....	ST7565R
•Number of data line.....	Serial/Parallel 6800/8080
	Series MPU interface
•Connector.....	FPC

2. MECHANICAL DATA

ITEM		WIDTH	HEIGHT	THICKNESS	UNIT
Module Size (include component of FPC)		56.5	36.8+18.8	6.0±0.3	mm
Resolution		128×64			dots
Active area		44.7	23.01	-	mm
Viewing area		51.0	26.0	-	
Dot	Size	0.32	0.33	-	mm
	Pitch	0.35	0.36	-	mm
Diameter of mounting hole		-			mm

3. ABSOLUTE MAXIMUM RATINGS

Operation Voltage	Symbol	Ratings
Operation Voltage	VDD	0.3V~3.6V
Drive Supply Voltage	VLCD	0.3V~14.5V
Input Voltage Range	VIN	-0.3V~VDD+0.3V
Operation Temperature	TOPR	0°C~50 °C
Storage Temperature	TSTR	-10 °C~60 °C
Humidity	---	90%RH

4. ELECTRICAL CHARACTERISTICS

Item		Symbol	Condition	Min.	Typ.	Max.	Unit
Supply Voltage	Logic	V _{DD}	---	---	3.0	---	V
Input Voltage	H level	V _{IH}	---	0.8V _{DD}	---	V _{DD}	V
	L level	V _{IL}		V _{SS}	---	0.2V _{DD}	
Current Consumption		I _{DD}	With internal V _{LCD} generation; V _{DD} =3.0V; Ta=25°C; 4x charge pump	---	---	250	uA
LCD Driving Voltage		V _{LCD}	Bias=1/9 VLCD=V0-Vss	8.8	9.0	9.2	V

4.1 LED ELECTRICAL/OPTICAL CHARACTERISTICS

Item	Symbol	Min.	Typ.	Max.	Unit	Condition
Forward Voltage	V _f	2.7	3.1	3.4	V	I _f = 45mA
Reverse Current	I _r	—	50	—	uA	V _r = 5 V
Dominant wave length	λ _p	—	X=0.29 Y=0.30	—	nm	I _f =45mA
Spectral Line Half width	Δ λ	—	—	—	—	I _f =mA
Luminance	L _v	80	100	—	cd/m ²	I _f = 45mA

4.2 LED ABSOLUTE MAXIMUM RATINGS

Item	Symbol	Condition	Rating	Unit
Reverse Voltage	V _r	T _a =25℃	5	V
Absolute maximum forward current	I _{fm}	T _a =25℃	75	mA
Power description	pd	T _a =25℃	375	mW

4.2.1 LED ARRAY BLOCK DIAGRAM

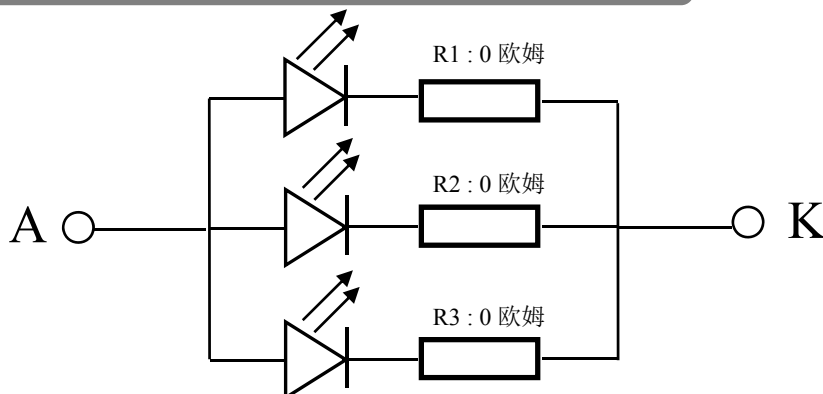

5. ELECTRO-OPTICAL CHARACTERISTICS

ITEM	SYMBOL	CONDITION	MIN.	TYP.	MAX.	UNIT	NOTE
Contrast ratio	K	$\varphi=0$	1.4	4	-	-	1
Response time (rise)	T_r	$\varphi=0$	-	250	300	ms	2
Response time (fall)	T_f	$\varphi=0$	-	250	350	ms	2
Viewing angle	φ	$K \geq 2.0$	-40 -- +40			deg.	3
	θ		-45 -- +15				

Note 1: Definition of Contrast Ratio "K"

$$K = \frac{\text{Brightness of non-selected segment(A)}}{\text{Brightness of selected segment(B)}}$$

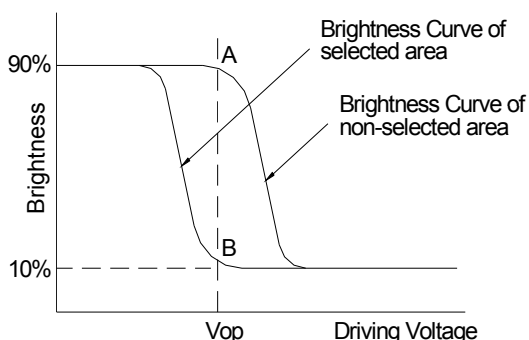

Note 2: Definition of Optical Response Time

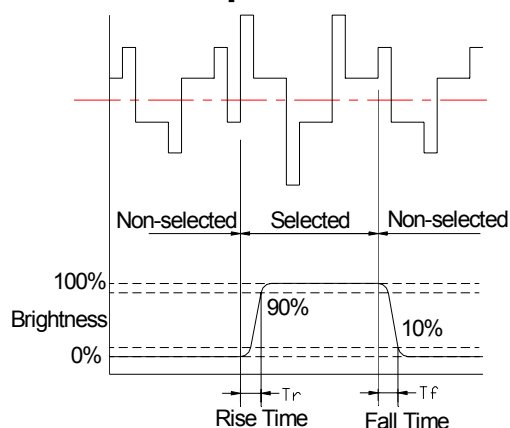

Note 3: Definition of Viewing Angle

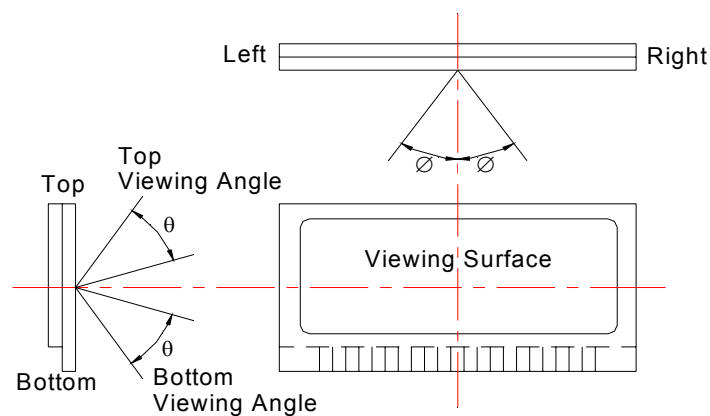

Please select either top or bottom viewing angle

6. BLOCK DIAGRAM

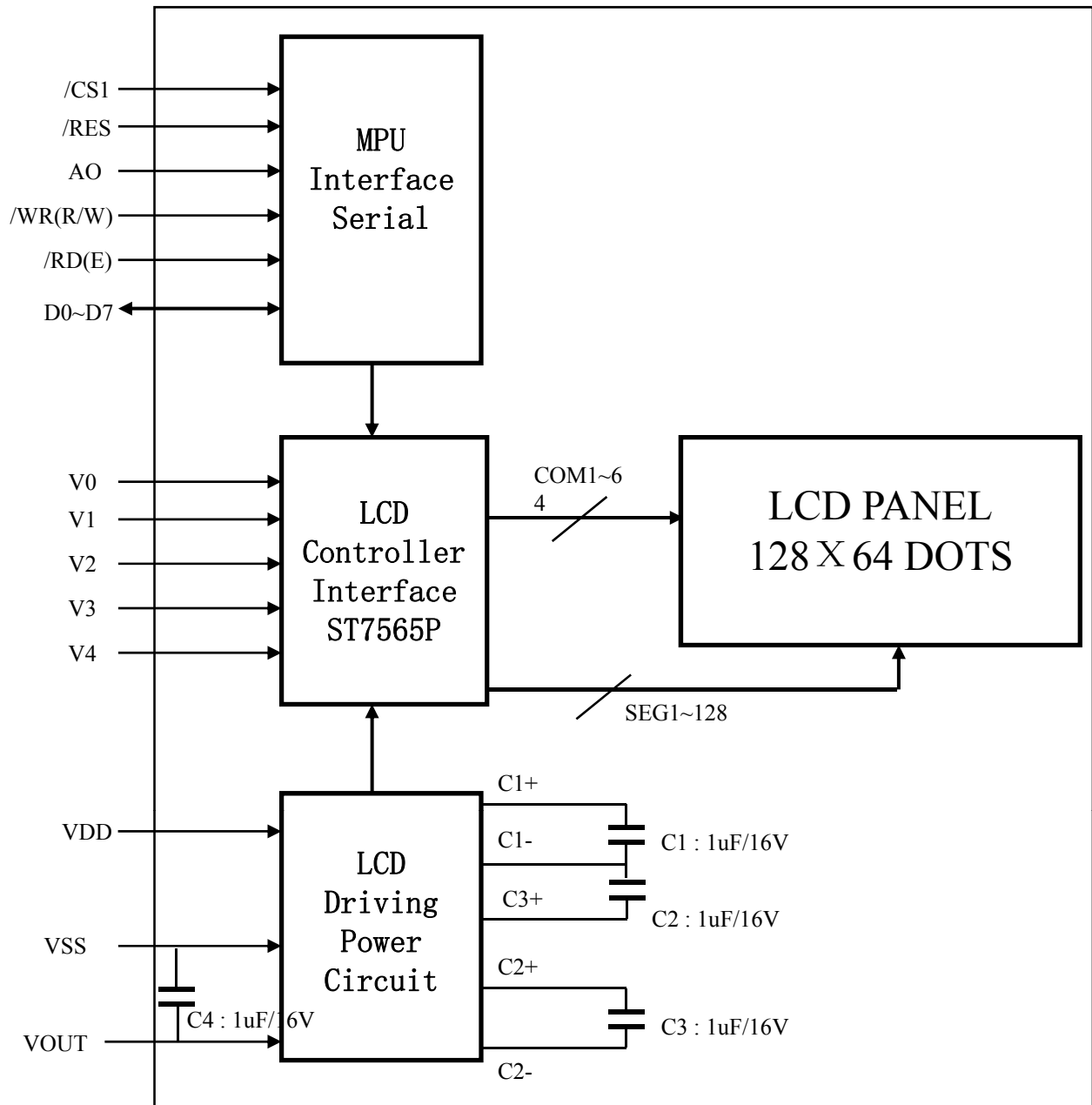

7. TIMING DIAGRAM

System Bus Read/Write Characteristics 1 (For the 8080 Series MPU)

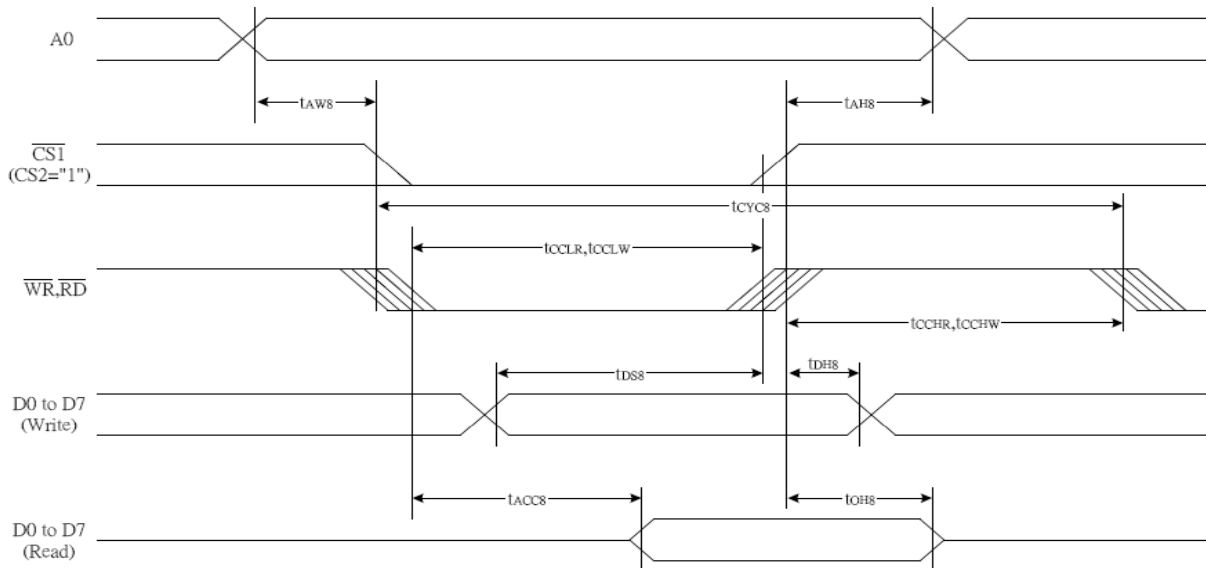

(VDD = 3.3V, Ta = -30 to 85°C)

Item	Signal	Symbol	Condition	Rating		Units
				Min.	Max.	
Address hold time	A0	tAH8		0	—	Ns
Address setup time		tAW8		0	—	
System cycle time		tCYC8		240	—	
Enable L pulse width (WRITE)	WR	tCCLW		80	—	
Enable H pulse width (WRITE)		tCCHW		80	—	
Enable L pulse width (READ)	RD	tCCLR		140	—	
Enable H pulse width (READ)		tCCHR		80	—	
WRITE Data setup time	D0 to D7	tDS8		40	—	
WRITE Address hold time		tDH8		0	—	
READ access time		tACC8	CL = 100 pF	—	70	
READ Output disable time		tOH8	CL = 100 pF	5	50	
Address hold time	A0	tAH8		0	—	ns
Address setup time		tAW8		0	—	
System cycle time		tCYC8		400	—	
Enable L pulse width (WRITE)	WR	tCCLW		220	—	
Enable H pulse width (WRITE)		tCCHW		180	—	
Enable L pulse width (READ)	RD	tCCLR		220	—	
Enable H pulse width (READ)		tCCHR		180	—	
WRITE Data setup time	D0 to D7	tDS8		40	—	
WRITE Address hold time		tDH8		0	—	
READ access time		tACC8	CL = 100 pF	—	140	
READ Output disable time		tOH8	CL = 100 pF	10	100	

System Bus Read/Write Characteristics 2 (For the 6800 Series MPU)

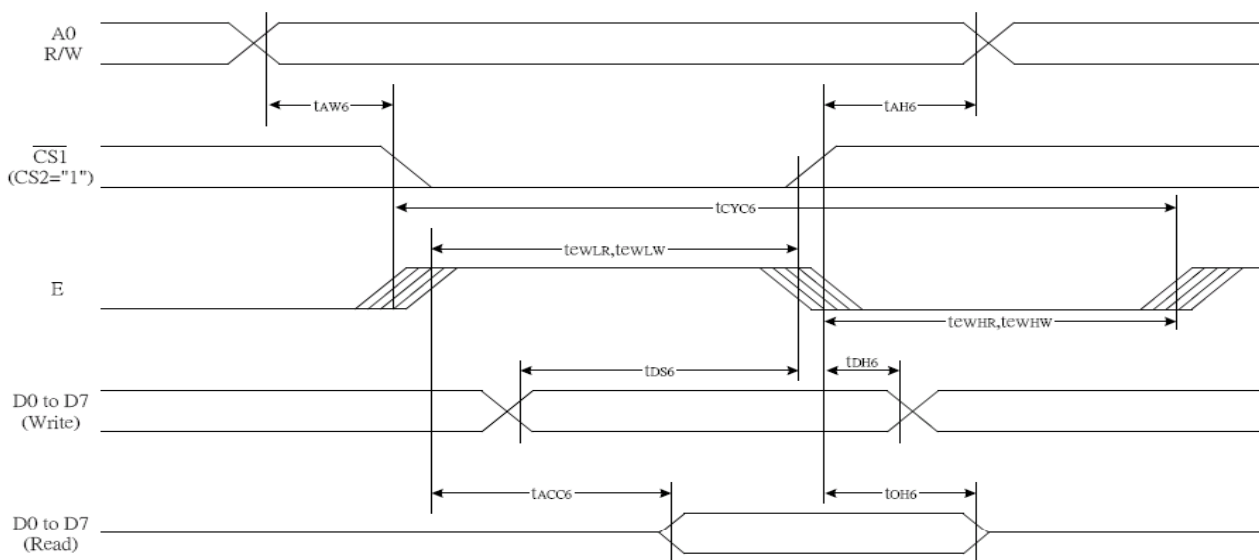

(VDD = 3.3V, Ta = -30 to 85°C)

Item	Signal	Symbol	Condition	Rating		Units
				Min.	Max.	
Address hold time	A0	tAH6		0	—	ns
Address setup time		tAW6		0	—	
System cycle time		tCYC6		240	—	
Enable L pulse width (WRITE)	WR	tEWLW		80	—	
Enable H pulse width (WRITE)		tEWHW		80	—	
Enable L pulse width (READ)	RD	tEWLR		80	—	
Enable H pulse width (READ)		tEWHR		140	—	
WRITE Data setup time	D0 to D7	tDS6		40	—	
WRITE Address hold time		tDH6		0	—	
READ access time		tACC6	CL = 100 pF	—	70	
READ Output disable time		tOH6	CL = 100 pF	5	50	
Address hold time	A0	tAH6		0	—	ns
Address setup time		tAW6		0	—	
System cycle time		tCYC6		400	—	
Enable L pulse width (WRITE)	WR	tEWLW		220	—	
Enable H pulse width (WRITE)		tEWHW		180	—	
Enable L pulse width (READ)	RD	tEWLR		220	—	
Enable H pulse width (READ)		tEWHR		180	—	
WRITE Data setup time	D0 to D7	tDS6		40	—	
WRITE Address hold time		tDH6		0	—	
READ access time		tACC6	CL = 100 pF	—	140	
READ Output disable time		tOH6	CL = 100 pF	10	100	

The Serial Interface

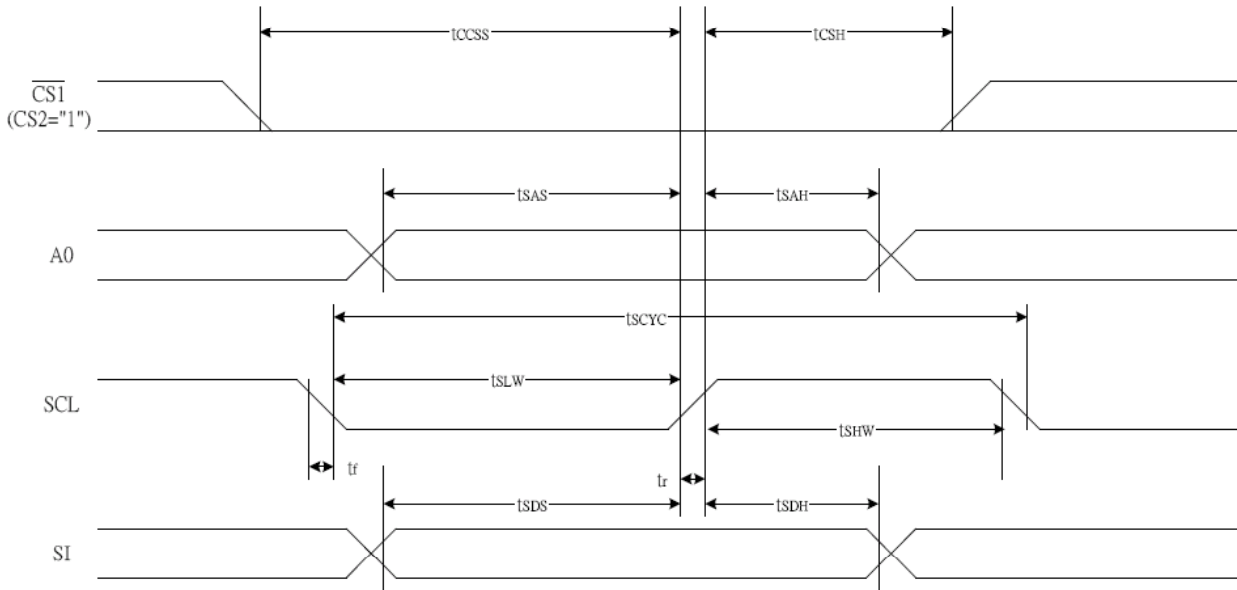

(VDD = 3.3V, Ta = -30 to 85°C)

Item	Signal	Symbol	Condition	Rating		Units
				Min.	Max.	
Serial Clock Period	SCL	T_{scyc}		50	—	ns
SCL "H" pulse width		T_{shw}		25	—	
SCL "L" pulse width		T_{SLW}		25	—	
Address setup time	A0	T_{SAS}		20	—	
Address hold time		T_{SAH}		10	—	
Data setup time	SI	T_{SDS}		20	—	
Data hold time		T_{SDH}		10	—	
CS-SCL time	CS	T_{CSS}		20	—	
CS-SCL time		T_{CSH}		40	—	

8. INSTRUCTION SET

Command	Command Code								Function			
	A0	/RD	/WR	D7	D6	D5	D4	D3		D2	D1	D0
(1) Display ON/OFF	0	1	0	1	0	1	0	1	1	1	0	LCD display ON/OFF 0: OFF, 1: ON
(2) Display start line set	0	1	0	0	1	Display start address					1	Sets the display RAM display start line address
(3) Page address set	0	1	0	1	0	1	1	Page address				Sets the display RAM page address
(4) Column address set upper bit	0	1	0	0	0	0	1	Most significant column address				Sets the most significant 4 bits of the display RAM column address. Sets the least significant 4 bits of the display RAM column address.
Column address set lower bit	0	1	0	0	0	0	0	Least significant column address				
(5) Status read	0	0	1	Status				0	0	0	0	Reads the status data
(6) Display data write	1	1	0	Write data								Writes to the display RAM
(7) Display data read	1	0	1	Read data								Reads from the display RAM
(8) ADC select	0	1	0	1	0	1	0	0	0	0	0	Sets the display RAM address SEG output correspondence 0: normal, 1: reverse
(9) Display normal/reverse	0	1	0	1	0	1	0	0	1	1	0	Sets the LCD display normal/reverse 0: normal, 1: reverse
(10) Display all points ON/OFF	0	1	0	1	0	1	0	0	1	0	0	Display all points 0: normal display 1: all points ON
(11) LCD bias set	0	1	0	1	0	1	0	0	0	1	0	Sets the LCD drive voltage bias ratio 0: 1/9 bias, 1: 1/7 bias (ST7555P)
(12) Read/modify/write	0	1	0	1	1	1	0	0	0	0	0	Column address increment At write: +1 At read: 0
(13) End	0	1	0	1	1	1	0	1	1	1	0	Clear read/modify/write
(14) Reset	0	1	0	1	1	1	0	0	0	1	0	Internal reset
(15) Common output mode select	0	1	0	1	1	0	0	0	*	*	*	Select COM output scan direction 0: normal direction 1: reverse direction
(16) Power control set	0	1	0	0	0	1	0	1	Operating mode			Select internal power supply operating mode
(17) V ₀ voltage regulator internal resistor ratio set	0	1	0	0	0	1	0	0	Resistor ratio			Select internal resistor ratio(Rb/Ra) mode
(18) Electronic volume mode set	0	1	0	1	0	0	0	0	0	0	1	Set the V ₀ output voltage electronic volume register
Electronic volume register set				0	0	Electronic volume value						
(19) Static indicator ON/OFF	0	1	0	1	0	1	0	1	1	0	0	0: OFF, 1: ON
Static indicator register set				0	0	0	0	0	0	0	0	0
(20) Booster ratio set	0	1	0	1	1	1	1	1	0	0	0	select booster ratio 00: 2x,3x,4x 01: 5x 11: 6x
(21) Power saver												Display OFF and display all points CN compound command
(22) NOP	0	1	0	1	1	1	0	0	0	1	1	Command for non-operation
(23) Test	0	1	0	1	1	1	1	*	*	*	*	Command for IC test. Do not use this command

9. INSTRUCTION SEQUENCE

I NIT:

```
LCALL DEL_20MS
CLR RESET
LCALL DEL_20MS
SETB RESET
LCALL DEL_20MS
MOV A,#81H
LCALL WC1
MOV A,BIAS
LCALL WC1

;MOV A,#84H
;LCALL WC1
;MOV A,#07H
;LCALL WC1
;MOV A,#82H
;LCALL WC1
;MOV A,#05H
;LCALL WC1

MOV A,#0A0H ;ADC
LCALL WC1
MOV A,#0C8H ;SHL
LCALL WC1
MOV A,#0A3H
LCALL WC1
MOV A,#2FH
LCALL WC1
MOV A,#25H
LCALL WC1
MOV A,#040H ;COM0
LCALL WC1
MOV A,#0AFH
LCALL WC1
RET
```

10. OUTLINE DRAWING

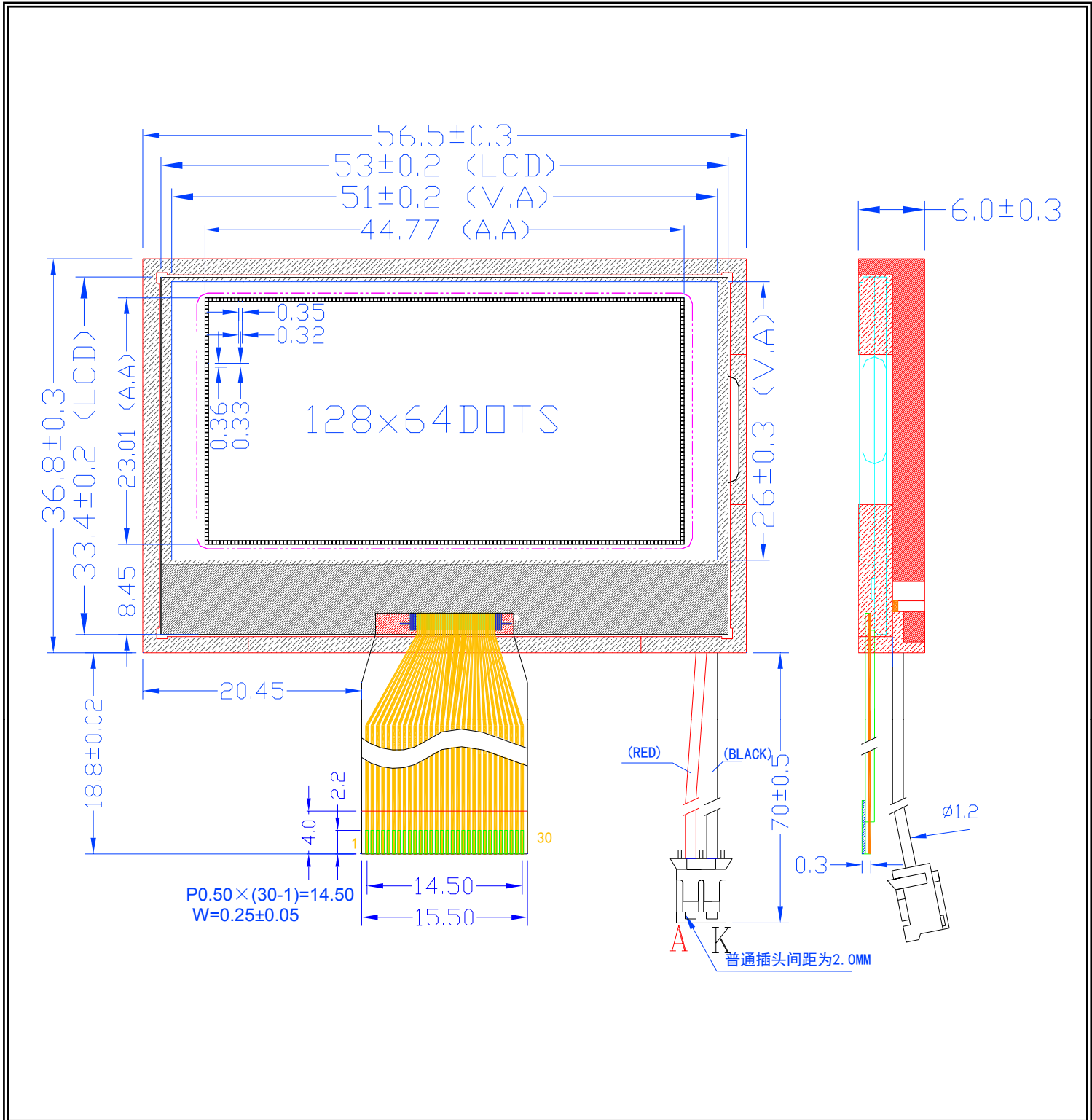

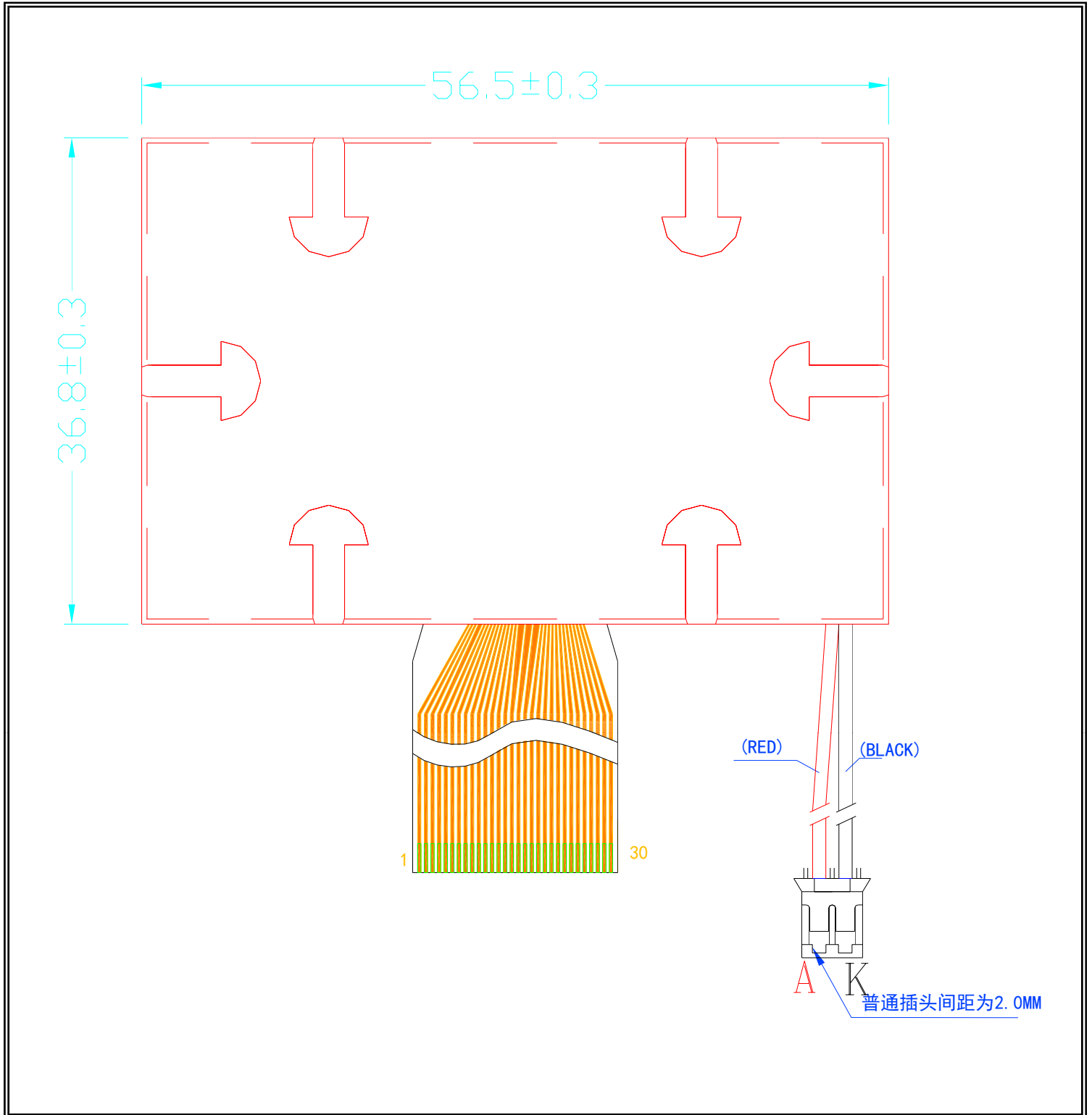

11.INTERFACE

PIN	SYMBOL	I/O	LEVEL	INSTRUCTION
1	INTRS	I	H/L	This terminal selects the resistors for the V0 voltage level adjustment. IRS = "H": Use the internal resistors IRS = "L": Do not use the internal resistors.
2	PS	I	H/L	This pin configures the interface to be parallel mode or serial mode. P/S = "H": Parallel data input/output. P/S = "L": Serial data input.
3	C86	I	H/L	This is the MPU interface selection pin. C86 = "H": 6800 Series MPU interface. C86 = "L": 8080 Series MPU interface.
4	VR	I	-	Output voltage regulator terminal. Provides the voltage between VSS and V0 through a resistive voltage divider. IRS = "L": the V0 voltage regulator internal resistors are not used. IRS = "H": the V0 voltage regulator internal resistors are used.
5~9	V0~V4	I/O	-	LCD drive supply voltage. The voltage determined by LCD pixel is impedance converted by an operational amplifier for application. Voltage should have the following relationship: $V0 \geq V1 \geq V2 \geq V3 \geq V4 \geq VSS$.
10	C2-	O	-	Capacitor 2 negative Connection pin for voltage converter.
11	C2+	O	-	Capacitor 2 positive Connection pin for voltage converter.
12	C1+	O	-	Capacitor 1 positive Connection pin for voltage converter.
13	C1-	O	-	Capacitor 1 negative Connection pin for voltage converter.
14	C3+	O	-	Capacitor 3 positive Connection pin for voltage converter.
15	VOU	I/O	-	Voltage converter input/output pin.
16	VSS	SUPPLY	L	Ground
17	VDD	SUPPLY	H	Power Supply Voltage
18~25	D7(SI) D6(SCL) D5~D0	I/O	H/L	This is an 8-bit bi-directional data bus that connects to an 8-bit or 16bit standard MPU data bus.
26	/RD (E)	I	H/L	8080:Read execution control pin. 6800:enable clock input control pin.
27	/WR (R/W)	I	H/L	8080:Write execution control pin. 6800:When R/W = "H": Read. When R/W = "L": Write.
28	A0	I	H/L	Register select input pin.
29	/RES	I	L	Reset select input pin,low effective.
30	/CS1	I	L	Chip select input pin,low effective.

12. QC/QA PROCEDURE

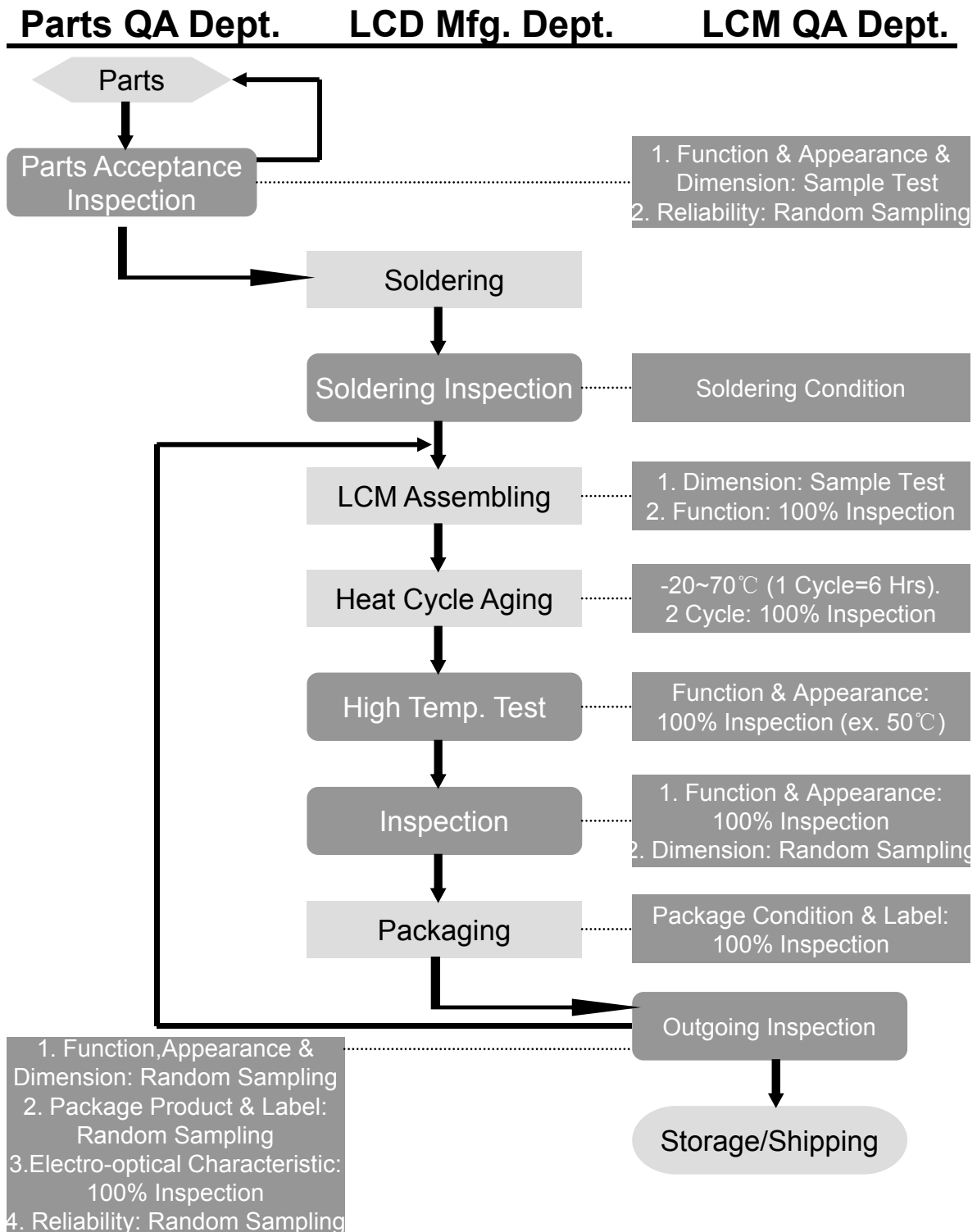

13. RELIABILITY

•Operating life time:

Longer than 50000 hours (at room temperature without direct irradiation of sunlight)

•Reliability Characteristics:

Item	Test	Criterion
High temp	70°C / 200 Hrs	■Total current consumption should be below double of initial value ■Contrast ratio should be within initial value±50% ■No defect in cosmetic and operational function is allowable
Low temp.	-20°C / 200 Hrs	
High humidity	40°C * 90%RH / 200 Hrs	
Thermal shock	-20°C→25°C→70°C→25°C /5 Cycles (30min) (5min) (30min) (5min)	
Vibration	1.Operating time: Thirty minutes exposure in each direction (x, y, z) 2.Sweep Frequency (1min):10Hz→55Hz →10Hz 3.Amplitude: 0.75mm double amplitude	

14. Handling Precaution

1. Limitation of Application:

Jing handa products are designed for use in ordinary electronic devices such as business machines, telecommunications equipment, measurement devices and etc. Please handle the products with care. (see below)

Jing handa products are not designed, intended, or authorized for use in any application which the failure of the product could result in a situation where personal injury or death may occur. these applications include, but are not limited to. life-sustaining equipment, nuclear control devices, aerospace equipment, devices related to hazardous or flammable materials, etc. [If Buyer intends to purchase or use the Jing handa Products for such unintended or unauthorized applications, Buyer must secure prior written consent to such use by a responsible officer of Jing handa Corporation.] Should Buyer purchase or use Jing handa Products for any such unintended or unauthorized application [without such consent]. Buyer shall indemnify and hold Jing handa and its officers, employees, subsidiaries, affiliates and distributors harmless against all claims, costs, damages and expenses, and reasonable attorney's fees, arising out of, directly or indirectly, any claim of personal injury or death associated with such unintended or unauthorized use, even if such claim alleges that Jing handa was negligent regarding the design or manufacture of the part.

2. Industrial Rights and Patents

Jing handa shall not be responsible for any infringement of industrial property rights of third parties in any country arising out of the application or use of Jing handa products, except which directly concern the structure or production of such products.

No Press and Shock!

If pressure to LCD, orientation may be disturbed.
LCD will broken by shock!

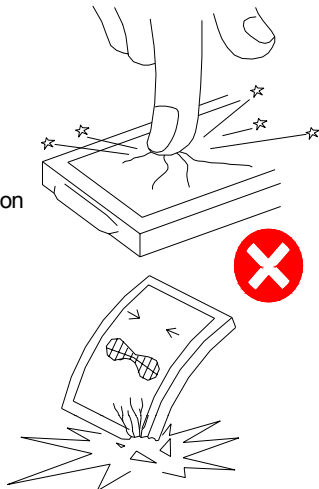

Don't Swallow or Touch Liquid Crystal!

Liquid Crystal may be leaked when display is broke.
If it accidentally gets your hands, wash then with water!

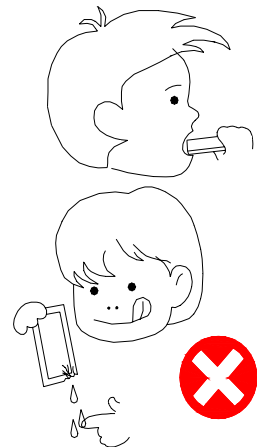

Don't not Scratch!

Polarizer is a soft material and can easily be scratched.

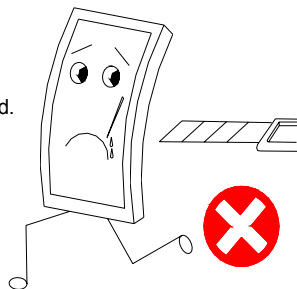

No DC Voltage to LCD!

DC volrage or driveing higher than the specified voltage will reduce the lifetime of the LCD.

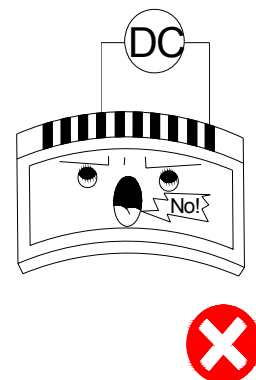

Don't Press the Metallic Frame and Disassemble the LCM

Pressure on the metallic frame and PCB may deform the conductive rubber or break the liquid crystal cell and back light, which will cause defects.

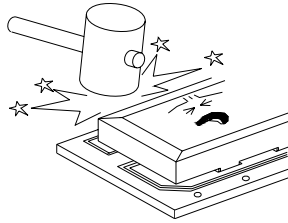

LCD may be shifted or conductive rubber may be reshaped, which will cause defects.

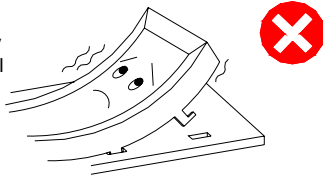

Slowly Peel Off Protective Film!

Avoid static electricity.

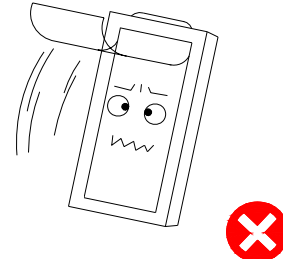

Avoid Static Electricity!

Please be sure to ground human body and electric appliances during work. It is preferable to use conductive mat on table and wear cotton clothes or conduction processed fiber. Synthetic fiber is not recommended.

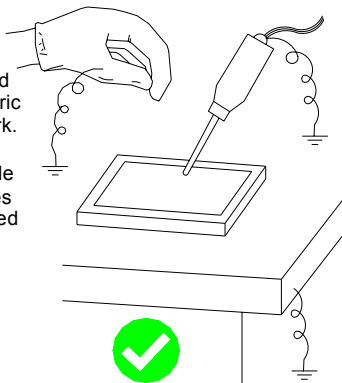

Wear Gloves While Handling!

It is preferable to wear gloves to avoid damaging the LCD.

Please do not touch electrodes with bare hands or make them dirty.

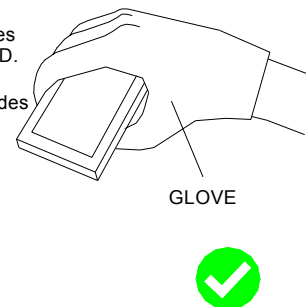

Keep Away From Extreme Heat and Humidity!

LCD deteriorates.

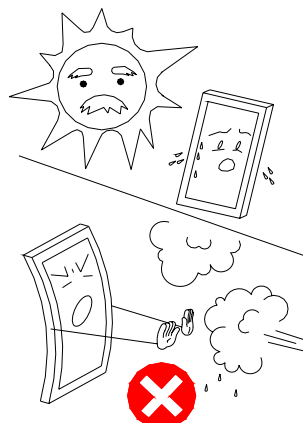

Use Alcohol to Clean Terminals!

When attaching with the heat seal or anisotropically conductive film, wipe off with alcohol before use.

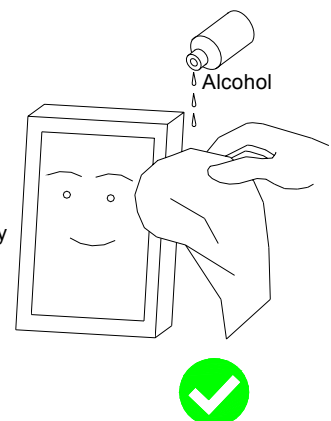

Don't Drop Water on LCD!

Note that the presence of waterdrops or dew in the LCD panel may deteriorate the polarizer or corrode electrode.

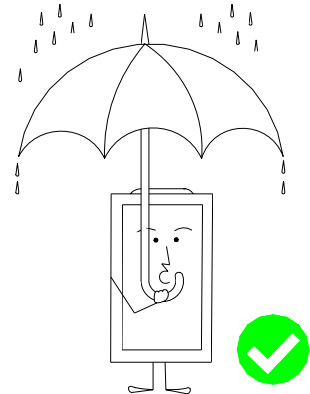
**Precaution in Soldering LCD Module**

Basic instructions: Solder I/O terminals only.

Use soldering iron without leakage.

(1) Soldering condition to I/O terminals

Temperature at tip of the iron: $280 \pm 10^{\circ}\text{C}$

Soldering time: 3~4 sec.

Type of solder: Eutectic solder (containing colophony-flux)

*Please do not use flux because it may soak into LCD Module or contaminate it.

*It is preferable to peel off protective film on display surface after soldering I/O terminals is finished.

(2) Remove connector or cable

*When you remove connector or cable soldered to I/O terminals, please confirm that solder is fully melted. If you remove by force, electrodes at I/O terminals may be damaged (or stripped off).

*It is recommended to use solder suction machine.

Long-term Storage

If it is necessary to store LCD modules for a long time, please comply with the following procedures.

If storage condition is not satisfactory, display (especially polarizer) may be deteriorated or soldering I/O terminals may become difficult (some oxide is generated at I/O terminals plating).

1. Store as delivered by Jing handa

2. If you store as unpacked, put in anti-static bag, seal its opening and store where it is not subjected to direct sunshine nor fluorescent lamp.

3. Store at temperature 0 to $+35^{\circ}\text{C}$ and at low humidity. Please refer to our specification sheets for storage temperature range and humidity condition.

Long-term Storage

Please use power supply with built-in surge protection circuit.