

HM30

FULL HD DIGITAL IMAGE TRANSMISSION SYSTEM USER MANUAL



V1.2

Dec 2021

Thank you for purchasing SIYI's product.

HM30 is a 30 km range, 150 ms low latency, 1080p full HD digital system based on the latest image transmission technology independently developed by SIYI. Abundant features and powerful performance make the system a commonly applied equipment of reliable FPV view, stable telemetry stream, and solid control on FPV wings, commercial drones, unmanned vehicles / boats, and robotics.

To maintain a safe and orderly public space and to ensure you a good experience of HM30 system, please read this manual carefully. If you have any issue using the product, please consult the manual or check the online pages of HM30 on SIYI's official website (<http://www.siyi.biz>). You can also write an email to SIYI official A/S center (support@siyi.biz).

SIYI User Group - Facebook



SIYI YouTube Channel (<https://www.youtube.com/c/SIYITech>)

SIYI Official AliExpress Store (<https://siyi.aliexpress.com>)

CONTENT

READ TIPS	1
Icons.....	1
Safety.....	1
Battery	3
Storage/Carrying/Recycling.....	4
1 INTRODUCTION	5
1.1 Product Features.....	5
1.2 Parts	7
1.2.1 At a Glance	7
1.2.2 Button/Switch Types and Default Channel Definitions.....	7
1.2.3 Ports on HM30 Ground Unit.....	8
1.2.4 Ports on HM30 Air Unit	9
1.2.5 OLED Function Display.....	10
1.3 Technical Specification.....	11
1.4 Packing List.....	13
1.5 Indicator Definition	14
1.5.1 Ground Unit Indicator	15
1.5.2 Air Unit Indicator.....	16
2 GET READY TO USE HM30	18
2.1 Ground Unit.....	18
2.1.1 Power On/Off.....	18
2.1.2 Charging.....	18
2.1.3 Charging Indicator.....	19
2.2 Important Instructions on Promotion to HM30 Communication Range and Video Fluency	19
2.2.1 Precautions on using HM30	20
2.2.2 Groud Unit Antenna Choice and Wireless Mode	21
2.2.3 Air Unit Antenna Choice.....	22
2.2.4 How to Mount the Standard Antenna on HM30 Ground Unit.....	23
2.2.5 How to Mount the Long-Range Antenna on HM30 Ground Unit.....	23
2.2.6 How to Place HM30 Air Unit Antenna.....	24
3 MENUS	26

3.1 Settings.....	26
3.1.1 Air Unit Number.....	28
3.1.2 Bind.....	28
3.1.3 RC Signal Input Mode.....	29
3.1.4 Datalink Output Mode.....	30
3.1.5 Datalink Baud Rate.....	32
3.1.6 AAT Baud Rate.....	33
3.1.7 Fail-Safe.....	34
3.1.8 RSSI Channel.....	35
3.1.9 Wireless Mode.....	36
3.1.10 Video Output Mode.....	38
3.2 Image Transmission and WiFi Status.....	40
3.2.1 Image Transmission Status.....	41
3.2.2 WiFi Status.....	42
3.3 Datalink and Remote-Control Status.....	42
3.4 Device Information.....	43
3.5 Mavlink Information.....	44
4 DATALINK.....	45
4.1 Communication with GCS via Bluetooth.....	45
4.2 Communication with GCS through UDP.....	47
4.3 Communication with PC or AAT through UART.....	48
4.4 Communication with PC through Type-C.....	49
4.5 Solutions to Disconnection.....	50
5 SIYI FPV APP.....	52
5.1 Settings.....	52
5.2 Link Status.....	53
5.3 About SIYI FPV.....	54
6 IMAGE TRANSMISSION.....	55
6.1 Using SIYI IP Cameras.....	56
6.2 Using Third-Party IP Cameras / Pods.....	56
6.3 Using HDMI Cameras / Pods.....	57
6.4 Dual Video Stream Connection.....	58

6.4.1 Dual SIYI IP Cameras	58
6.4.2 Dual Third-Party IP Cameras	59
6.4.3 SIYI HDMI Converter and SIYI IP Camera	59
6.4.4 SIYI HDMI Converter and Third-Party IP Camera	60
6.4.5 Dual SIYI HDMI Converter	60
6.5 Common IP Addresses	61
6.6 Output HM30 Ground Unit Video Stream	62
6.6.1 Through Internal WiFi to Android Mobile Device	62
6.6.2 Through USB WiFi to Android Mobile Device.....	63
6.6.3 Through Type-C Port.....	63
6.6.4 Through LAN Port to Windows PC.....	64
6.6.5 Through the LAN Port and the HDMI Converter to HDMI Monitor	65
6.7 Solutions to No Image	68
6.7.1 Video Output through WiFi and Display on A Mobile Device.....	68
6.7.2 Video Output through USB and Display on A Mobile Device.....	70
6.7.3 Video Output through WiFi or LAN on A Windows Device.....	71
7 Firmware Upgrade.....	74
7.1 HM30 RF Firmware Upgrade	74
7.2 Upgrade HM30 Ground Unit HDMI Output Converter's Built-in FPV System	76
8 After-sale Service	78
8.1 Repair Service	78
8.2 Warranty	79
8.2.1 7-Day Return & Refund.....	79
8.2.2 15-Day Replacement.....	80
8.2.3 1-Year Warranty Repair	82

READ TIPS

Icons

Please pay more attention to content indicated with the following marks:

 **DANGER** Dangerous manipulation probably leads to human injuries.

 **WARNING** Warnings on manipulation possibly leads to human injuries.

 **CAUTION** Cautions on what manipulation may lead to property loss.

 **Prohibited**  **Mandatory**  **Mark**

Safety

HM30 Full HD FPV System is designed for professional application in specific industries, users who approach to the equipment should have at least the basic knowledge to operate it. Irregular or irresponsible manipulations to the device may cause damage, property loss, or human injuries. Users under 14 years' old should follow an experienced trainer's guide. Disassembling or modification to the system is prohibited without permission from its manufacturer, SIYI Technology.

To maintain a safe and orderly public space and to ensure you a good using experience of SIYI's products, please read the prohibited and mandatory terms carefully.

⊘ Do not use any SIYI system to operate your aircraft/vehicle/model at places with intensive crowd (a square, a park), or at places with many obstructions (a street, a parking lot), or in fields with strong magnetic or interference (an electricity plant, a radar station, railways), or in any other fields where an irregular flight/operation may cause property loss or human injuries.

⊘ Do not hold or cover the ground unit antenna or obstruct its transmission by any means in a flight or in an operation.

⊘ Never point the ground unit antenna's top ends straightly to your aircraft/vehicle while it is working, they are the weakest parts for transmission.

⊘ Do not start your aircraft/vehicle/model when you are tired, drunk, in sickness or in any circumstances you are not feeling good.

⊘ Do not fly an aircraft/model when it is rainy, windy or at night.

⊘ Do not power off the ground unit while your aircraft's/vehicle's/model's engines and motors are still working.

❗ Please always try to operate your aircraft/vehicle/model within sight range.

❗ Before a flight, please return to the starting menu on the ground unit.

❗ Do not forget to check battery level of the ground unit and the air unit before starting your aircraft/vehicle/model.

❗ Always power off your aircraft/vehicle/model first, HM30 ground unit the second.

 Before configuring any settings on the ground unit, make sure your aircraft's/vehicle's/model's engines are powered off and their motor wires are disconnected, in case of a sudden switch-on.

 When you start your aircraft/vehicle for the first time, make sure that the fail-safe settings on your ground unit is activated.

 Always switch on the ground unit first and hold the throttle joystick on your remote controller at zero output position, then power on your aircraft/vehicle/model.

Battery

HM30 ground unit is compatible the movie-industry-level NP-F550/F570/F950 series high capacity chargeable li-ion battery. Please do read the precautions before using the battery with HM30 and charging the battery through HM30.

 Please power off the HM30 ground unit before charging. The ground unit does not allow charging while it is working.

 Stop charging immediately if you found the charger damaged, broken or overheat.

 Stop charging immediately if there was a peculiar smell, smokes or leaks from the battery. In such cases you shall sent the product back to your dealer for after-sales service.

 Do not charge the ground unit when its temperature is over 60°C.

Storage/Carrying/Recycling

When your SIYI products are stand idle, or you are bringing it outdoors, or the system reached service life, then please do read the precautions below.



CAUTION

Always place your SIYI products at places where babies or kids do not reach.



DANGER

SIYI products should be placed in places with below conditions:

Not too hot (above 60°C) or too cold (under -20°C).

Not under direct sunshine or too dusty or too wet.

Not on an unstable holder which lacks solid supports or may cause vibration.

Not nearby steam or other heat sources.

1 INTRODUCTION

1.1 Product Features

30KM 1080P Full HD Image Transmission

HM30 applies SIYI's brand new and cutting edge high-definition image transmission technology with the ability to transmit 1080p 60fps video stream at *150ms low latency. The technology comes with a smart feature to adapt its transmission to better frequency bands, which means it always goes to work on the band with least interference. With the standard omni directional antennas, HM30's effective range can reach up to 15 kilometers. With the long-range antennas, the range can be up to 30 kilometers with full HD image transmission, real-time telemetry, and stable control.

**The 150ms latency is an average result measured by using SIYI standard IP camera under the following conditions:*

H.265 format, 720p @ 30 fps, displayed in QGC v4.1 (low-latency mode): end-to-end latency is between 130 and 180ms.

H.265 format, 1080p @ 30 fps, displayed in QGC v4.1 (low-latency mode): end-to-end latency is between 180 and 250ms.

SIYI will release a new 1080p @ 60fps camera to effectively lower latency even more.

OSD Telemetry Display

Working with HM30, SIYI FPV app supports Mavlink telemetry overlaid with OSD display. The OSD display information can be customized. FPV OSD with full HD image will bring you endless fun.

Network Relay, Dual Remote Control

HM30 will support Dual RC function, under which two ground units can bind to one air unit to control flight and payloads at the same time. RC Relay function expands the communication range for HM30.

**The features are in development and will come soon.*

OLED Touchscreen Display and Configuration

The OLED touchscreen on HM30 ground unit displays its working status in real-time and supports fast parameter configuration. Much more convenience for outdoor flights!

Quick Release Battery, PD Fast Charging

Power supply to HM30 ground unit uses fast-release structure design for popular battery models such as NP-F550/570/950 series. Max 30W PD fast charging can be used to charge the battery through the transmitter.

You can use a 7 to 16.8 V external power for HM30 ground unit through its XT30 connector.

1.2 Parts

1.2.1 At a Glance

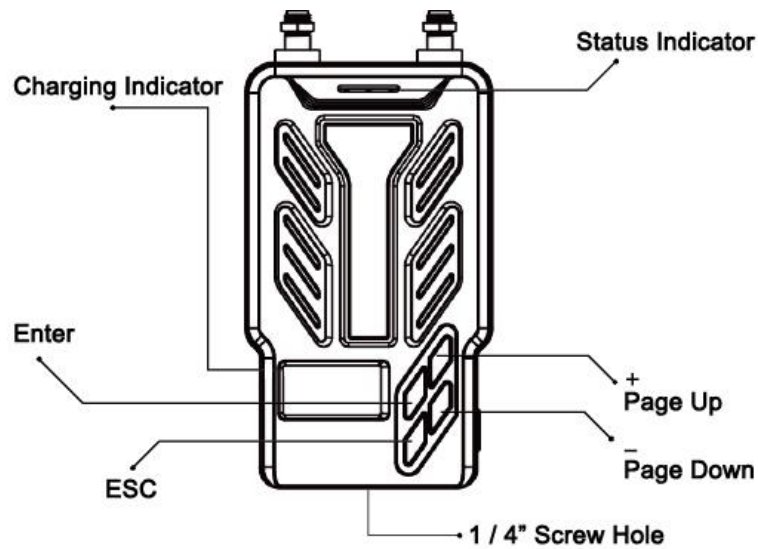

1.2.2 Button/Switch Types and Default Channel Definitions

HM30 supports up to 16 communication channels in total. Channel 10 to 14 are mapped with PWM 1 to 5 in default.

1.2.3 Ports on HM30 Ground Unit



<p>RC RC Signal Input</p>	<p>PPM / S.Bus / UART S.Port Gnd 5V 500ma</p>
<p>UART Datalink Output</p>	<p>RX TX Gnd 5V 500 mA</p>
<p>LAN Ethernet Port</p>	<p>RX- RX+ TX- TX+</p>
<p>VCC Power Output</p>	<p>Gnd Gnd VCC 7-17V VCC 7-17V</p>
<p>Type-C Charging / Transferring</p>	
<p>PWR Power Input</p>	<p>Gnd VCC 7 ~ 16.8 V</p>

1.2.4 Ports on HM30 Air Unit

HM30 Air Unit Interface Definition

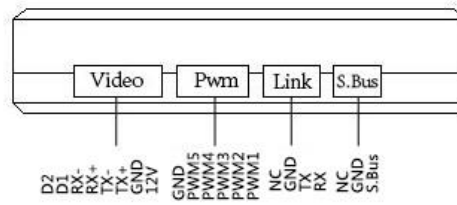
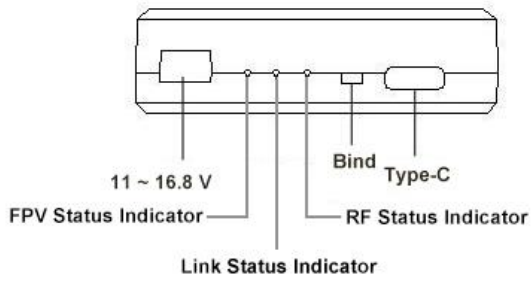
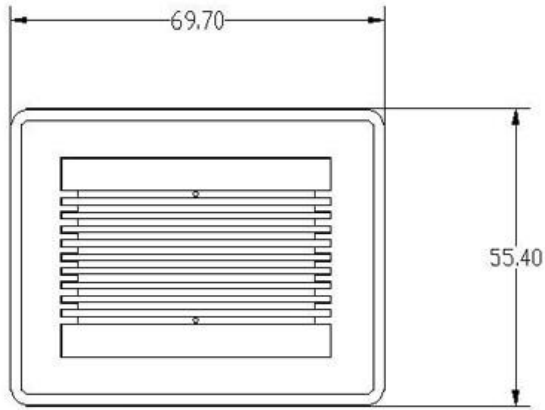

1.2.5 OLED Function Display

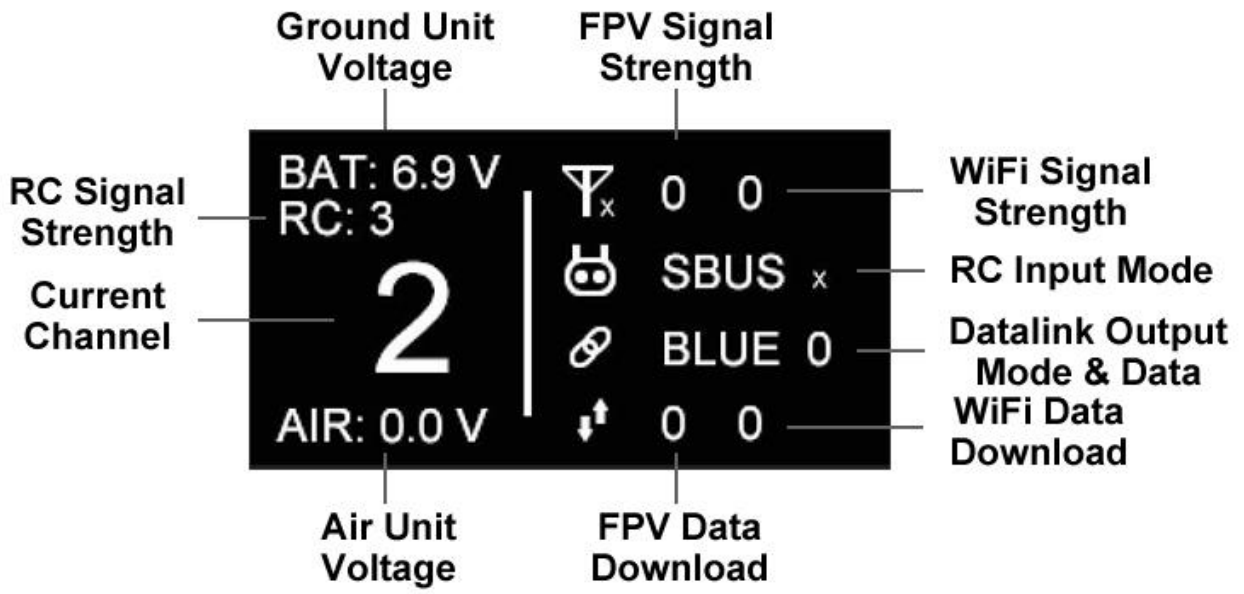

Signal Strength Range: 0 ~ 100

1.3 Technical Specification

Overall

Max Transmission Distance	30 km (Unobstructed, free of interference)
Channels	16 communication channels
Datalink Supported FC	Open-Source FC Pixhawk or APM SN+, SN-NAVI MATEK H743 / F405 Or any other flight controllers with UART datalink output
FPV Supported GCS (Standard RTSP stream)	QGroundControl SIYI FPV

Ground Unit

Monitor Display	0.96-inch OLED Screen
Dimension	189 x 138 x 41 mm (Antenna and battery excluded)
Weight	132 g (Antenna and battery excluded)
Supported Battery Type	NP-F550 / F750 / F770 / F950 / F970 series fast-release batteries (HM30 Fly More Combo comes with NP-F750 battery)
Fast Charging Protocol	PD 30 W
Antenna Gain	Standard Omni Antenna: 5 dBi Standard Directional Antenna: 11 dBi
Power Consumption	5 W
Interface & Ports	S.Bus / PPM RC Signal Input: RC (GH1.25 4-pin) Datalink Output: UART (GH1.25 4-pin) Ethernet Port: LAN (GH1.25 4-pin) Power Output: VCC (GH1.25 4-pin) USB Video Output / Charging / Firmware Upgrade / USB WiFi: Type-C Power Input: PWR (XT30) Tripod Connector: 1/4-inch screw hole

Waterproof Level	IP53
Working Temperature	-10℃ ~ 50℃

Air Unit

Signal Output	16 channels of SBUS 5 channels of PWM
Interface & Ports	S.BUS: 3-Pin Datalink (to FC): UART (GH1.25 4-Pin) PWM Channel 1-5: 6-Pin Video Input: 8-Pin Firmware Upgrade: Type-C
Dimension (Antenna excluded)	70 x 55 x 16 mm (Fan included)
Weight (Antenna excluded)	74 g
Antenna Gain	Standard Omni Antenna: 5 dBi
Power Input	11 ~ 16.8 V (Expandable to 14 ~ 58.8 V with BEC)
Working Temperature	-10℃ ~ 50℃

FPV Camera

Max Resolution	720p 30fps 1.57Mbps H.265 <i>(Or 1080p 30fps 2.3Mbps H.265 only as the reference to DIY configuration)</i>
Sensor	1/2.9" CMOS
Effective Pixel	300 Mp
Lens	3.2 mm, f/2.8
Camera Angle	FOV 120°
Dimension	42 x 42 x 25 mm
Weight	23 g
Cable Length	1000 mm

Working Temperature	-10℃ ~ 55℃
----------------------------	------------

Ground Unit HDMI Output Module

HDMI Port Type	Standard HDMI Port
Power Consumption	2.5 W
Dimension	52 x 52 x 16 mm
Weight	150 g
Working Temperature	-10℃ ~ 55℃

1.4 Packing List

FPV Combo	Fly More Combo
	1 x HM30 Ground Unit 2 x Standard Omni Antenna 2 x Directional Antenna
	1 x HM30 Air Unit 2 x Standard Omni Antenna
	1 x Ground Unit S.Bus Signal Cable 1 x Ground Unit RJ45 Video Cable 1 x Ground Unit XT30 Male Power Cable
	1 x PIX Telemetry Cable 1 x Air Unit Signal Cable 1 x PWM Cable

<p>1 x Type-C to Type-C Charging Cable</p> <p>1 x Type-C to USB-A Converter</p> <p>1 x Type-C to Micro-USB Cable</p>	
<p>1 x IP Camera</p>	
	<p>1 x 20W PD Charger</p> <p>1 x NP-F750 2S Chargeable Battery</p>

Ground Unit HDMI Output Module

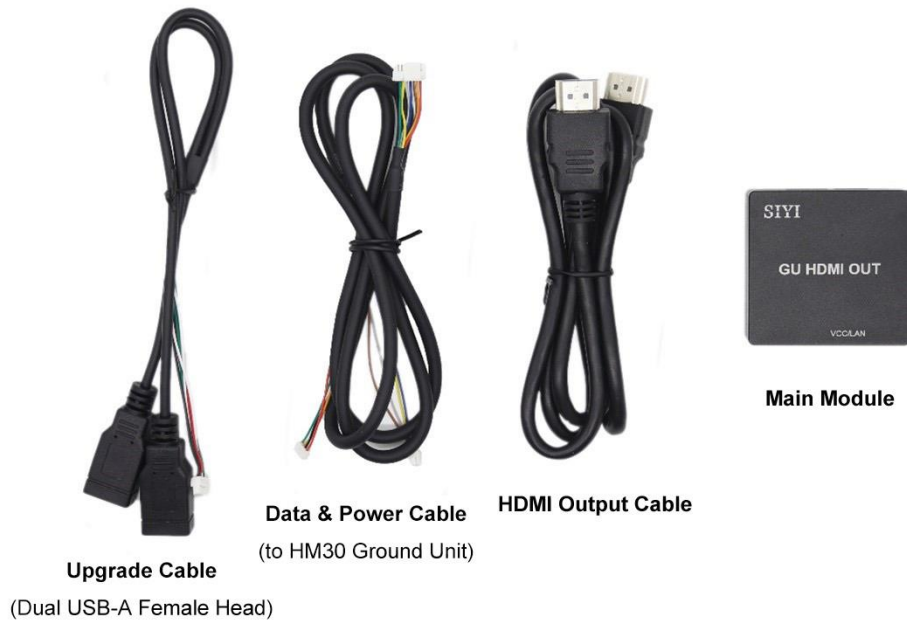

1.5 Indicator Definition

The status indicators on HM30 ground unit and HM30 air unit use three different colors and different blinking frequencies to indicate the system's working or

abnormal status.

1.5.1 Ground Unit Indicator

- Fast Red Blinks: Ground unit is binding to air unit.
- Solid Red: No communication between ground unit and air unit.
- Slow Red Blinks: RF firmware does not match.
- ● ● Triple Red Blinks: FPV initialization failed.
- ● Fast Red-Yellow Blinks: FPV firmware does not match.
- ● ● Slow Red-Blue-Yellow Blinks: FPV is starting.
- ● ● Fast Red-Blue-Yellow Blinks: Firmware updating.
- Fast Yellow Blinks: Power input voltage is out of range.
- Slow Yellow Blinks: Ground unit FPV data overload alert, level two.
- ● ● Triple Yellow Blinks: Ground unit FPV data overload alert, level one.
- ● Double Yellow Blinks: Ground unit Bluetooth is not identified.
- ● Yellow-Red Blinks: Ground unit overheat alert, level one.
- ● ● Yellow-Red-Red Blinks: Ground unit overheat alert, level two.
- ● ● ● Yellow-Red Blinks: Ground unit overheat alert, level three.
- Solid Blue: Perfect communication, receiving 100% data package.
- Blue Blinks: Blinking frequency indicates the system's signal quality. More frequently it blinks, worse the signal quality is.
- Slow Blue Blinks: Receiving 95% to 99% data package.
- Blue Blinks (every 3/5 second): Receiving 50% to 75% data package.

- Blue Blinks (every 3/10 second): Receiving 25% to 50% data package.
- Blue Blinks (every 1/25 second): Receiving less than 25% data package.
- ● Double Blue Blinks: Failsafe set successfully.
- ● Blue-Red Blinks: Air unit overheat alert, level one.
- ● ● Blue-Red Blinks: Air unit overheat alert, level two.
- ● ● ● Blue-Red Blinks: Air unit overheat alert, level three.

1.5.2 Air Unit Indicator

- Solid Red: No communication between transmitter and receiver.
- Fast Red Blinks: Ground unit is binding to air unit.
- Slow Red Blinks: RF Firmware does not match.
- ● ● Triple Red Blinks: FPV initialization failed.
- ● ● Slow Red-Blue-Yellow Blinks: FPV is starting.
- ● ● Fast Red-Blue-Yellow Blinks: Firmware updating.
- Yellow Blinks: Air unit low voltage alert (voltage input lower than 12V).
- Solid Blue: Perfect communication, 100% data package received.
- Blue Blinks: Blinking speed indicates the system's signal strength. More frequently it blinks, worse the signal quality is.
- Slow Blue Blinks: 95% to 99% data package received.
- Blue Blinks (every 3/5 second): 50% to 75% data package received.
- Blue Blinks (every 3/10 second): 25% to 50% data package received.
- Green Blinks (every 1/25 second): less than 25% data package received.

● ● Fast Blue-Red Blinks: Air unit starts to bind wirelessly (plug power three times to trigger).

● ● Blue-Red Blinks: Air unit overheat alert, level one.

● ● ● Blue-Red-Red Blinks: Air unit overheat alert, level two.

● ● ● ● Blue-Red-Red-Red Blinks: Air unit overheat alert, level three.

2 GET READY TO USE HM30

2.1 Ground Unit

2.1.1 Power On/Off

Power On: Short press and long press combo.

When HM30 ground unit is off power, press the power button once, the OLED screen will display “press again”. Then immediately press and hold the power button for about two seconds, ground unit starts working.

Power Off: Long press.

When HM30 ground unit is working, press the power button once, the OLED screen will display “press again”. Then immediately press and hold the power button for about two seconds, ground unit will be turned off.

2.1.2 Charging

When HM30 ground unit is mounted the external NP-F750 series chargeable battery and the ground unit is power off, you can charge the battery through HM30 ground unit using the original PD fast charger.

1. Connect HM30 ground unit to the PD charger with the original Type-C fast charging cable and plug into power.
2. If the charging indicator is on red, the ground unit is charging.

3. If the charging indicator is on green, charging is finished.



CAUTION

HM30 ground unit cannot be charged when it is working. Please do power off the ground unit before charging.

NP-F550 / F-750 / F-950 fast-release battery series are suggested to work with HM30 ground unit.

2.1.3 Charging Indicator

- Solid Red: In charging.
- Solid Green: Charging finished.

2.2 Important Instructions on Promotion to HM30 Communication Range and Video Fluency

In order to have the best communication range and video fluency with HM30 / MK15 system, please carefully read the below tips for choosing/mounting antenna and module configuration.

2.2.1 Precautions on using HM30

1. There are four ways to acquire the video stream from HM30 ground unit: USB, Internal WiFi, USB WiFi, and Ethernet.
2. When the environmental temperature is high or there is direct sunshine, it is suggested not to use the Internal WiFi for video sharing to reduce internal heat.
3. It is also suggested not to run SIYI FPV and QGroundControl at the same time, not even running one at backstage, as it still occupies bandwidth thereby lower the communication range.
4. Only power battery and the SIYI original BEC are allowed to power the XT30 connectors on HM30 ground unit and the air unit directly. HD image transmission requires high standard to the current level, the instancy of the current response, and the current ripple, so power supply from the third-party BEC or from FC may interfere the link stability and the image transmission range.
5. When you use a mobile device to connect with HM30 ground unit's internal WiFi for video display, mind that the distance between your mobile device and the ground unit should be within one meter. If you expect for longer distance to connect the mobile device, please use the USB WiFi modules selling by SIYI with optional transmitting power.

6. It will cause video freeze or extra latency when the battery level of your mobile device is low or its temperature is high, because the decoding speed is lower in such circumstances.

2.2.2 Ground Unit Antenna Choice and Wireless Mode

1. 0 to 10 Kilometers FPV Flight

Two standard omni-directional antennas on MK15 ground unit.

Wireless mode: 5 to 8 km low latency.

Omni antenna signal is the worst on top direction, please fly within 100-meter distance from home point.

2. 10 to 20 Kilometers GCS Flight

Two standard directional antennas on HM30 ground unit.

Wireless mode: 24 km long range.

Route flight through GCS is suggested as the antenna is directional.

Antenna is directional. Your drone must fly in front of your antenna and should not fly in the opposite direction or fly top.

3. 20 to 30 Kilometers GCS Flight

High gain antenna (17 to 20 dBi) on HM30 ground unit.

Wireless mode: 24 km long range.

Route flight through GCS is suggested as the antenna is directional.

4. 40 Kilometers GCS Flight

**For professional users only*

High gain antenna (17+ dBi) on HM30 ground unit.

Wireless mode: 40 km long range.

This is not the mode for everyone. Please do not try to use it. Without high gain antennas, the signal quality could be bad, and the video stream could freeze occasionally!

2.2.3 Air Unit Antenna Choice

Only the standard omni antenna is suggested for HM30 / MK15 air unit. Quantity is two pieces.

For small planes or who worries about the signal from the top, and who does not care about the very long range, welcome to use the SIYI original lollipop antenna.

2.2.4 How to Mount the Standard Antenna on HM30 Ground Unit

1. The SMA connector should be screwed tightly.
2. The antenna should stand vertically, and its flat side should always point to your aircraft or vehicle.
3. Do not cross the two antennas.
4. The two antennas should be amounted apart from each other for about 10 cm distance, at least 5 cm, to ensure that they transmit and receive signals well.

2.2.5 How to Mount the Long-Range Antenna on HM30 Ground Unit

1. The SMA connector should be screwed tightly.
2. The panel side should always point to your aircraft or vehicle.
3. Please make its short side in horizontal directional and its long side in vertical direction. On the air unit, the antenna top should be in vertical direction and point to the ground.
4. Please be very careful with the antenna cable's SMA connector and its solder point. Do not drag it or bend it in case of any damage. To adjust the position of the antenna, always try to bend the middle part of the antenna cable.

5. The two antennas should be amounted apart from each other for about 10 cm distance, at least 5 cm, to ensure that they transmit and receive signals well.

2.2.6 How to Place HM30 Air Unit Antenna

1. The SMA connector should be screwed tightly.
2. On a quadcopter, the air unit antenna should be hanged vertically from the carbon fiber board or the arms with the head pointing downward, and its flat side should always point to the ground unit in most flight altitudes.
3. On a plane, the antenna can stand vertically from the wings.
4. The antenna cable should be placed far away from E.S.C and motors, or some other equipment with heavy current or interference. The antenna cable should not cross.
5. The antenna body or the SMA connector should not touch the metal/carbon-fiber parts directly. At least 10 mm distance should be reserved.
6. The two antennas should be mounted apart from each other for at least 5 cm distance. And try the best to avoid any kind of obstruction during flight.
7. Please be very careful with the antenna cable's SMA connector and its solder point. Do not drag it or bend it in case of any damage. To adjust the position of the antenna, always try to bend the middle part of the antenna cable.

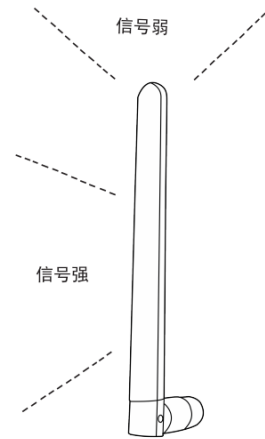
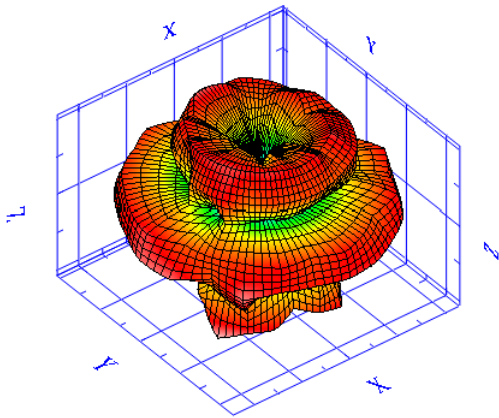

Transmitting Angle of the Standard Omni Antenna



Air Unit Antenna Installation on Quadcopters

3 MENUS

Users can configure HM30 ground unit in the built-in OLED screen.

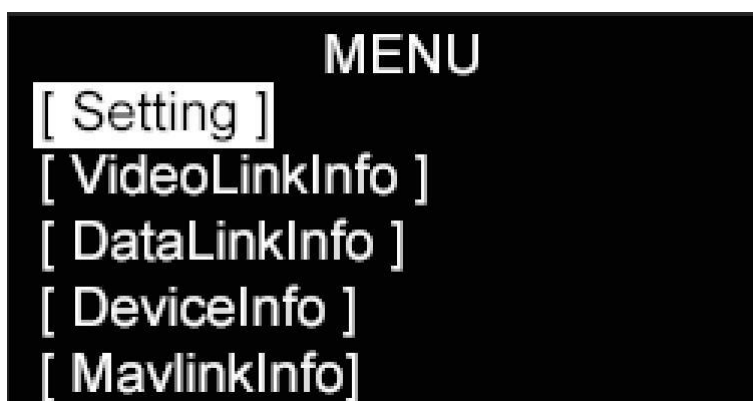
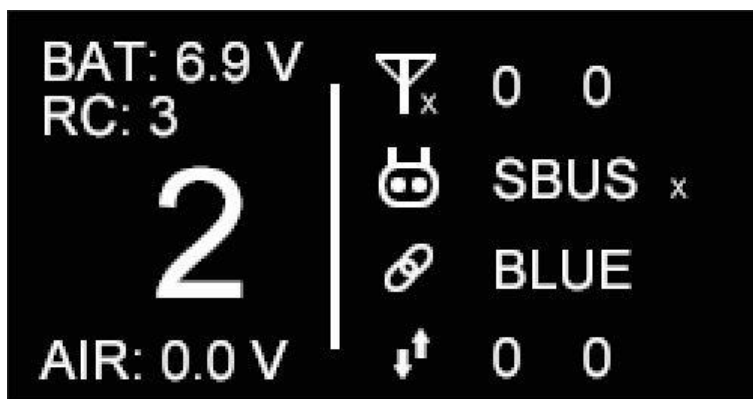

Mark

This chapter was made according to HM30 ground unit firmware version 0.1.7.

3.1 Settings

Basic functions of the HM30 ground unit.

```

SETTING 1 / 2
Rec. No: 00 Bind
RC Mode: UART x
Datalink Mode: Blue
BAUD: 115200
AAT. BAUD: 115200
    
```

```

SETTING 2 / 2
FailsafeSet: Set
RSSI. CH: 8
Wireless. Mode: 8KM. FPV
Video Mode: Inter WiFi
    
```

About Settings

Rec. No (Air Unit No.): Display the number of the currently bound air unit. (In development)

Bind: Binding button.

RC Mode: Display the current RC signal input mode on HM30 ground unit.

Datalink Mode: Display the current datalink output mode on HM30 ground unit.

Baud: Datalink communication baud rate.

AAT. Baud: Antenna tracker communication baud rate.

FailsafeSet (Failsafe Settings): Set failsafe function on HM30 ground unit.

RSSI CH (RSSI Channel): Set the RSSI output channel on HM30 ground unit.

Wireless Mode: Set the wireless mode for HM30 system.

Video Mode: Set the video output mode on HM30 ground unit.

3.1.1 Air Unit Number

HM30 ground unit will be capable to bind multiple air units. The function is still in development.

3.1.2 Bind

Please follow the below steps to bind HM30 ground unit and HM30 air unit.



1. Press “+” and “-” buttons to move the cursor to “Bind” and press the “Enter” button.
2. The ground unit status indicator starts to blink red fast. And “bind” turns to “binding”.
3. Then press the binding button on the air unit for two seconds. The air unit status indicator starts to blink red fast as well.

4. Then please wait for 5 to 10 seconds till the status indicators on HM30 ground unit and air unit turn to solid blue. Binding is finished.

3.1.3 RC Signal Input Mode

HM30 supports three RC signal input modes. S.Bus, PPM, and UART.



1. Press “+” and “-” buttons to move the cursor to the current RC signal input mode and press the “Enter” button.
2. The OLED screen will alert “Do not configure (this function) in flight in case of losing control!”



3. Press the “Enter” button again to go to the submenu of “RC Mode”.
4. Move the cursor to select your target RC signal input mode.

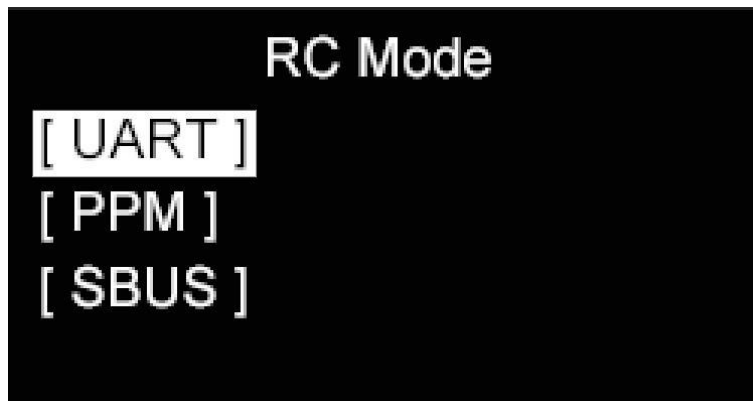

5. Back to the “Settings” page, if there is the “x” icon after the selected mode, it means there is no RC signal input. If the icon is “←→”, there is RC signal input through the current mode.

3.1.4 Datalink Output Mode

HM30 ground unit supports four ways to output datalink stream. Bluetooth, Type-C, UART serial port, and UDP.



About Datalink Output Mode

Blue: Datalink output through Bluetooth.

Type-C: Datalink output through the Type-C port on HM30 ground unit.

UART: Datalink output through the UART port on HM30 ground unit.

UDP: Datalink output through UDP network.

1. Press “+” and “-” buttons to move the cursor to the current datalink output mode and press the “Enter” button.
2. The OLED screen will alert “Do not configure (this function) in flight in case of losing control!”



3. Press the “Enter” button again to go to the submenu of “Datalink Mode”.
4. Move the cursor to select your target datalink output mode.

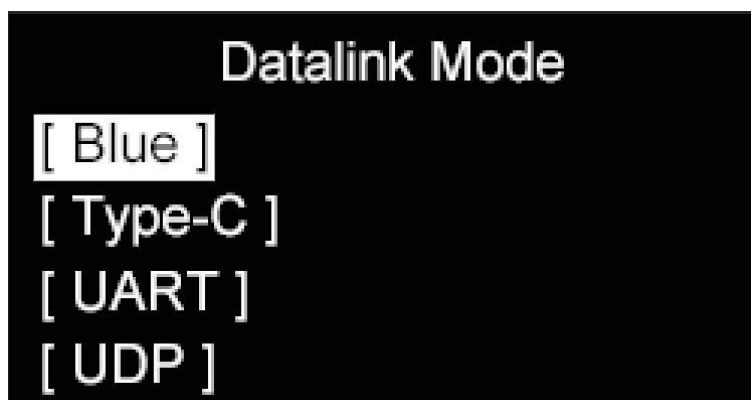

Mark

When the datalink output mode is Bluetooth, UDP, or Type-C, the UART serial port on HM30 ground unit will output only downloading data for AAT function. When the datalink output mode is UART, the port will have both uploading and downloading data.

For more detail about datalink output, please refer to the Chapter 4 “Datalink” in this user manual.

3.1.5 Datalink Baud Rate

HM30 supports different baud rates for datalink communication. The available baud rates are 9600, 38400, 57600, 115200, and 230400.

A screenshot of the HM30 OLED display showing the following settings: SETTING 1 / 2, Rec. No: 00 Bind, RC Mode: UART x, Datalink Mode: Blue, BAUD: 115200, and AAT. BAUD: 115200. The value 115200 is highlighted with a white box.

```
SETTING 1 / 2
Rec. No: 00 Bind
RC Mode: UART x
Datalink Mode: Blue
BAUD: 115200
AAT. BAUD: 115200
```

1. Press “+” and “-” buttons to move the cursor to the current datalink baud rate and press the “Enter” button.
2. The OLED screen will alert “Configure (this function) in communication with the air unit!”

WARNING
* Do not configure in flight
in case of losing control !

3. Press the “Enter” button again to go to the submenu of “Datalink Baud Rate”.
4. Move the cursor to select your target datalink baud rate.

Mark

When the datalink output mode is UART, changing the datalink baud rate will change the baud rate of the UART port on HM30 ground unit and HM30 air unit.

3.1.6 AAT Baud Rate

HM30 supports two baud rates for AAT communication. 57600 and 115200.

```

SETTING      1 / 2
Rec. No: 00   Bind
RC Mode: UART x
Datalink Mode: Blue
BAUD: 115200
AAT. BAUD: 115200
    
```

1. Press “+” and “-” buttons to move the cursor to the current AAT baud rate and

press the “Enter” button to switch.

2. Every time the “Enter” button is pressed, the AAT baud rate will be switched between 57600 and 115200.

Mark

When the datalink output mode is UART, the configuration will not take effect.

When the datalink output mode is Bluetooth, Type-C, or UDP, the configuration will take effect.

3.1.7 Fail-Safe

HM30 supports configuring Failsafe function with the remote controller.



1. Press “+” and “-” buttons to move the cursor to the second page of the “Settings” menu.
2. Then go to “Set” after “FailsafeSet” and press the “Enter” button.



3. The OLED screen will alert “Configure (this function) in communication with the air unit!” and “Need to connect (HM30 ground unit) with remote controller!”.
4. Press the “Enter” button again, HM30 ground unit will read the channel output value from the current RC signal and set it as the failsafe channel value.

Mark

When the HM30 ground unit was not in communication with the air unit, the function will not take effect.

When the HM30 ground unit was not connected with the remote controller, the function will not take effect.

3.1.8 RSSI Channel

HM30 supports customizing the RSSI output channel.



1. The “OFF” value after “RSSI CH” indicates that the RSSI channel output is disabled. If the value is a number, it indicates the current RSSI output channel.
2. Press “+” and “-” buttons to move the cursor to the RSSI channel value and press “Enter” button to switch channels.

Mark

The available RSSI output channels on HM30 are from communication channel 5 to channel 16.

3.1.9 Wireless Mode

HM30 supports switching wireless mode to be compatible with antennas in different types and gains and to reach the best communication performance and the longest range.

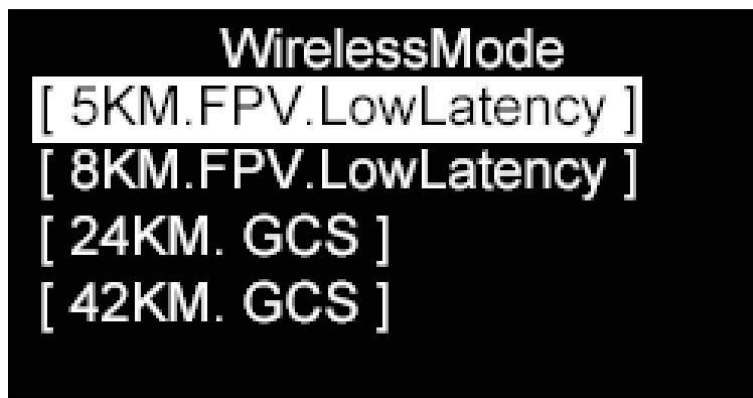

About Wireless Mode

5KM. FPV. LowLatency: 5-kilometer low latency FPV flight mode.

8KM. FPV. LowLatency: 8-kilometer low latency FPV flight mode.

24KM. GCS: 24-kilometer GCS long range mode.

42KM. GCS: 42-kilometer GCS long range mode.

1. Press “+” and “-” buttons to move the cursor to the second page of the “Settings” menu.
2. Then go to “Wireless Mode” and press the “Enter” button.



3. The OLED screen will alert “Do not configure (this function) in flight in case of losing control!” and “Configure (this function) in communication with the air unit!”.
4. Press the “Enter” button again to go to the submenu of “Wireless Mode”.
5. Select your required wireless mode and press the “Enter” button to confirm.

Mark

Please carefully read the Chapter 2.2 “Important Precautions on Promotion to HM30 Communication Range” in this manual before using this function.

3.1.10 Video Output Mode

HM30 supports four ways to output video stream. Internal WiFi, USB WiFi, Type-C Port and LAN port.



About Video Output Mode

Inter WiFi / Upgrade: Video output through internal WiFi module in HM30 ground unit or the HM30 ground unit is under firmware upgrade process through the Type-C port.

USB: Video output through the Type-C port on HM30 ground unit.

Type-C WiFi: Video output through an external USB WiFi module connected to the Type-C port on HM30 ground unit.

1. Press the “+” and the “-” buttons to move the cursor to the video output mode and press the “Enter” button.
2. The OLED screen will alert “Do not configure (this function) in flight in case of losing control!”



3. Press the “Enter” button again to go to the submenu of “Video Mode”.
4. Move the cursor to select your target video output mode.

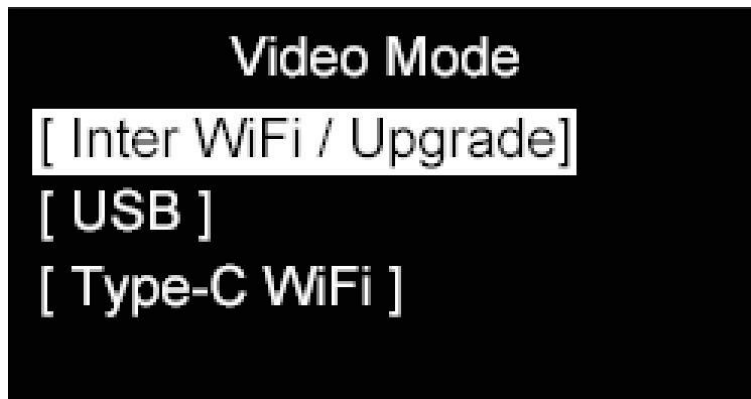

Mark

For more detail on outputting video stream, please refer to the Chapter 6 “Image Transmission” in this manual.

3.2 Image Transmission and WiFi Status

Through “Image Transmission and WiFi Status” we can have a general view to the communication status of the image transmission link and the WiFi link.

3.2.1 Image Transmission Status

```

          VIDEO INFO   1 / 2
CH: 104      Signal: 0
RSSI: 0      Ntime: 0
UpB: 0.0     DownB: 0.0
UPData:      0.0 KB
DownData:    0.0 KB
    
```

About Image Transmission Status

CH: The current communication channel.

Signal: Image transmission signal quality (in percentage, from 0 to 100).

RSSI: Image transmission signal strength (in dBm).

Ntime: Communication latency of the image transmission link. The latency time will accumulate when the link loses communication.

Up B: Uploading bandwidth.

Down B: Downloading bandwidth.

Up Data: Uploading data.

Down Data: Downloading data.

3.2.2 WiFi Status

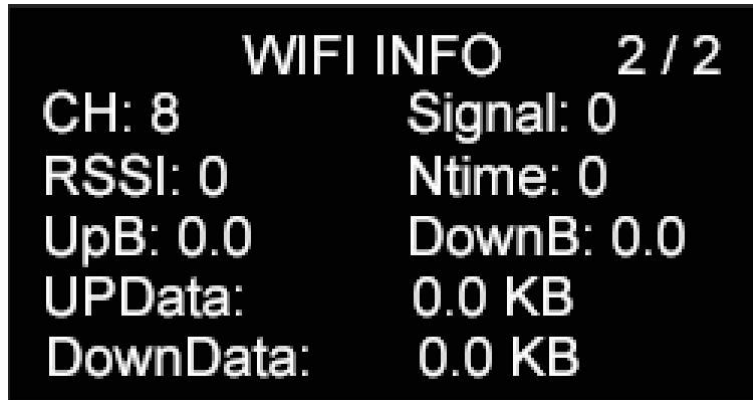

About WiFi Status

CH: The current communication channel.

Signal: WiFi signal quality (in percentage, from 0 to 100).

RSSI: WiFi signal strength (in dBm).

Ntime: Communication latency of the WiFi link. The latency time will accumulate when the link loses communication.

Up B: Uploading bandwidth.

Down B: Downloading bandwidth.

Up Data: Uploading data.

Down Data: Downloading data.

3.3 Datalink and Remote-Control Status

Through “Datalink and Remote-Control Status” we can have a general view to the

communication status of the Datalink and Remote-Control link.

DATALINK INFO	
Freq:	3
ValidPack:	3
PackRate:	3
DataUp:	0
DataDown:	0

About Datalink and Remote-Control Status

Frequency: The current communication frequency band.

Valid Pack: Valid package.

Pack Rate: Valid package rate (in percentage).

Data Up: Uploading data.

Data Down: Downloading data.

3.4 Device Information

Through “Device Information” we can have a general view to the hardware and the software information of HM30 system.

```
DEVICE INFO    1 / 2
HardID: 6A02259766
FirmwareVer: 0.1.7
SkyFirmwareVer: 0.0.0
VideoVer: 0.2.2
SkyVideoVer: 0.0.0
```

```
DEVICE INFO    2 / 2
LoaderVer: 0.1.0
```

About Device Information

Hard ID: Item ID of the HM30 hardware.

Firmware Ver.: RF firmware version of HM30 ground unit.

Sky Firmware Ver.: RF firmware version of HM30 air unit.

Video Ver.: FPV firmware version of HM30 ground unit.

Sky Video Ver.: FPV firmware version of HM30 air unit.

Loader Ver.: Boot loader version of HM30 ground unit.

3.5 Mavlink Information

The Mavlink information is for reference only.

4 DATALINK

Datalink is one of the core features of most SIYI radio systems.

HM30 ground unit supports communication with different ground control software through various hardware interface.

4.1 Communication with GCS via Bluetooth

Let's take QGroundControl as an example.

1. On HM30 ground unit, go to "Settings" and set "Bluetooth" for "Datalink Mode", and configure the correct baud rate.
2. On your mobile device or your laptop, turn on Bluetooth and search the Bluetooth device starting with the ID "SIYI-6A*****"), and pair. The PIN code is "1234".
3. Open QGC, go to "Application Settings - Comm Links" and "Add" a new connection.

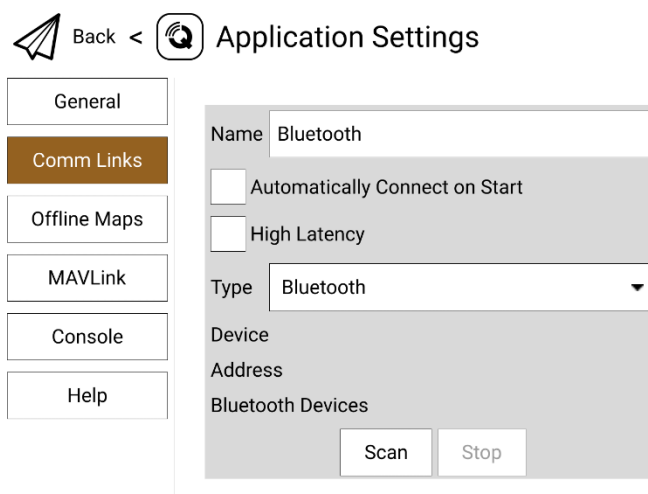

4. Set the "Type" as "Bluetooth", then touch "Scan".

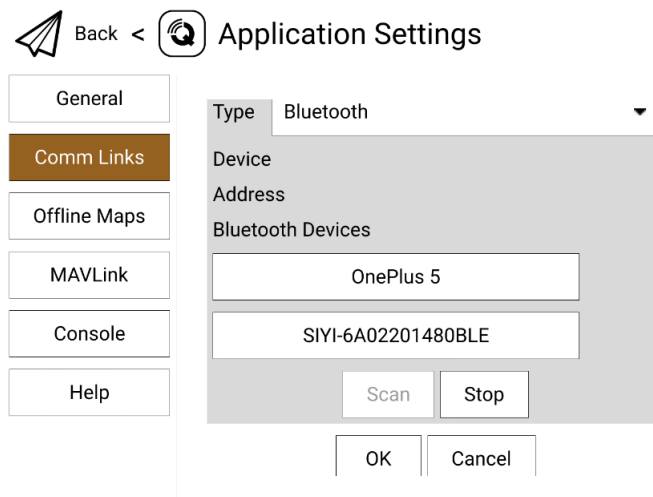

5. Select the Bluetooth device starting with the ID “SIYI-6A*****”, then “OK” to go back to the “Comm Links” page.

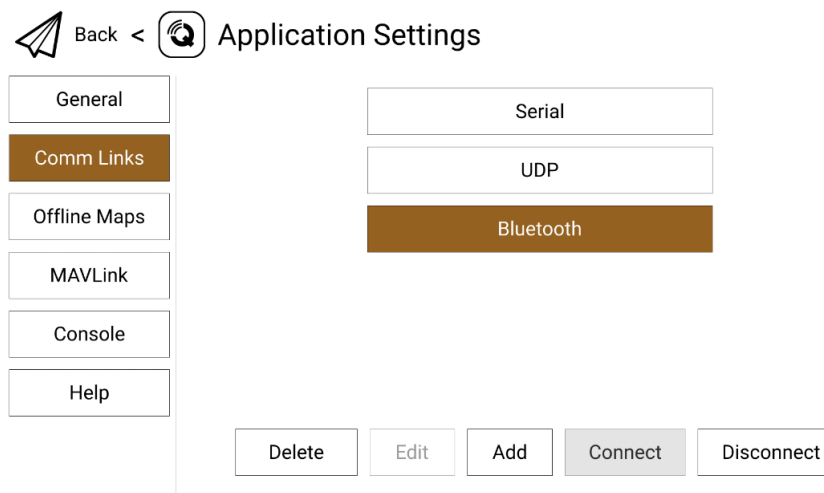

6. Select “Bluetooth” and touch “Connect”, Bluetooth connection is established.

Mark

If it is your first time to add a new connection in QGC “Comm Links”, please do not check the option “Automatically Connect on Start”. It can be checked later when you confirm that the datalink is connected successfully.

4.2 Communication with GCS through UDP

Let's take QGroundControl as an example.

1. On HM30 ground unit, go to "Settings" and set "UDP" for "Datalink Mode", and configure the correct baud rate.
2. UDP connection uses fixed IP for network communication, please set the IP address for your connected mobile device or Windows device as "192.168.144.20". Like in the picture below.

● 使用下面的 IP 地址(S):

IP 地址(I):	192 . 168 . 144 . 20
子网掩码(U):	255 . 255 . 255 . 0
默认网关(D):	192 . 168 . 144 . 12

3. Open QGC, go to "Application Settings - Comm Links" and "Add" a new connection.

Back < Application Settings

- General
- Comm Links**
- Offline Maps
- MAVLink
- Console
- Help

Name: UDP

Automatically Connect on Start

High Latency

Type: UDP

Note: For best performance, please disable AutoConnect to UDP devices on the General page.

Port: 19856

Server Addresses (optional)

192.168.144.12 Add Server

4. Name the connection as "UDP", set the "Type" as "UDP", the "Port" as "19856", the "Server Addresses" as "192.168.144.12". Then "Add Server" and click "OK" to return to the "Comm Links" page.

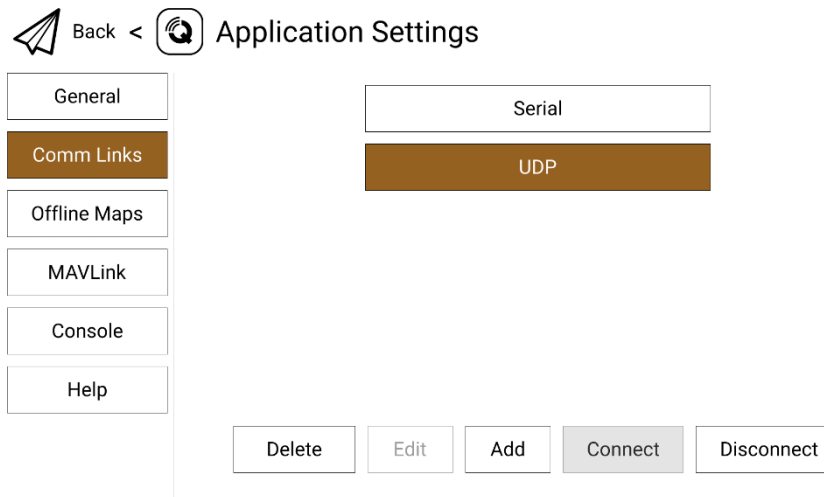

5. Touch the configured “UDP” connection and touch “Connect”, UDP connection is established.

Mark

If it is your first time to add a new connection in QGC, please do not check the option “Automatically Connect on Start”. It can be checked later when you confirm that the datalink is established successfully.

4.3 Communication with PC or AAT through UART

The UART port on HM30 ground unit, connected to a Windows device or other embedded device through the 4-Pin to USB-A cable, can be used as a transparent data transmission port. It can also connect to an antenna tracker (AAT).

1. On HM30 ground unit, go to “Settings” and set “UART” for “Datalink Mode”, and configure the correct baud rate. Changing the baud rate will change the UART port’s baud rate as well.
2. Please refer to the pin map of HM30 ground unit. Wire the “TX” pin from the UART port to the “RX” pin from the antenna tracker and wire the “RX” pin from the UART port to the “TX” pin from the antenna tracker. “GND” pin to “GND” pin.
3. The UART datalink connection is established.

Mark

Antenna trackers from different manufacturers may have different operating logistics. If the AAT device is paired to the HM30 ground unit via Bluetooth, then please ignore the wiring steps. For more detail, please refer to their user manual.

When the “Datalink Mode” is configured as Bluetooth, UDP, or Type-C, through the UART port on HM30 ground unit there will still be downloading data for antenna trackers. The antenna tracker baud rate can be changed according to your requirement.

4.4 Communication with PC through Type-C

Let’s take Mission Planner as an example.

1. On HM30 ground unit, go to “Settings” and set “Type-C” for “Datalink Mode”, and configure the correct baud rate.
2. Connect HM30 ground unit to the Windows device through the Type-C to USB-A cable, the windows device will recognize HM30 ground unit as a COM device.

3. Open Mission Planner, select the correct COM port for HM30 ground unit and configure the baud rate.



4. The Type-C datalink connection to Mission Planner is established.

Mark

If the HM30 ground unit cannot be recognized as a COM device by your Windows device, please open “Computer – Manage – Device Manager” and check if there were any abnormal drivers. If so, please download and install the relevant drivers to solve the issue.

4.5 Solutions to Disconnection

If HM30 system failed to establish the datalink connection with the GCS, please try to follow the steps below to investigate possible reasons.

1. Confirm if the HM30 air unit is connected to your flight controller through the correct telemetry cable.
2. If it is a DIY telemetry cable, please check:
 - If the correct pin map is followed?
 - If the “TX” pins go to the “RX” pins?
 - If any of the wires are defect?

3. On HM30 ground unit, go to “Datalink and Remote-Control Link Status” page to check the information to confirm if the flight controller are in good communication with the HM30 air unit.

When the communication is good, “Data Download” is not 0. If it is “0”, please go back to check step 1 and 2 again.

4. Go to “Settings – Datalink Mode” page and check:

- If the datalink output mode is correct?
- If the baud rate is correct?

5. In your GCS, check if “Datalink Connection” type is correct.

Mark

If you have done investigation by following all steps above, but the reason is still not located, please contact your dealer or contact SIYI Support immediately.

5 SIYI FPV APP

SIYI FPV is an Android application developed by SIYI and for configuring image transmission, displaying video stream, and monitoring link status on HM30 image transmission system, MK15 and MK15E smart controllers.

SIYI FPV System Display Interface Definition

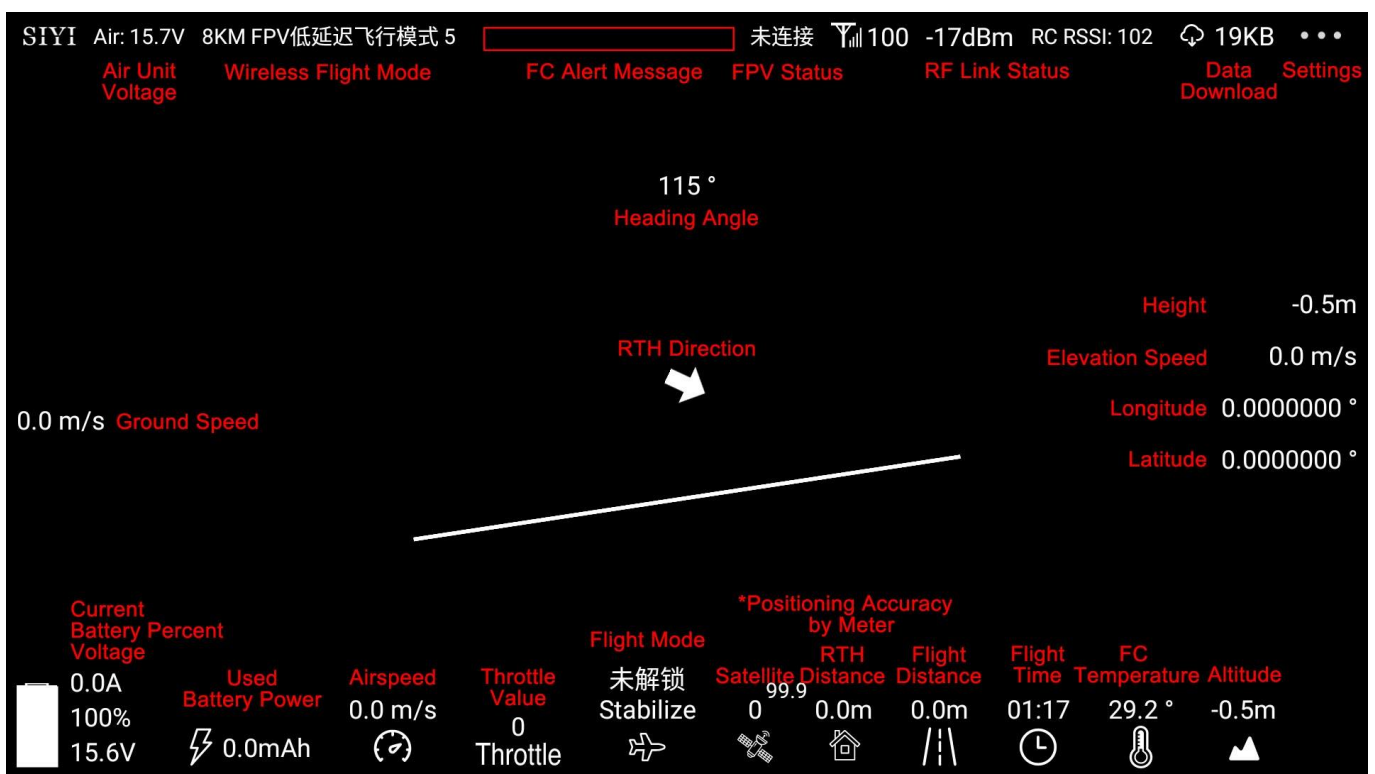

5.1 Settings

In the “Settings” page, you can switch the “Decoding Type”, configure the “IP Addresses”, and enable the “Cross Sight”.

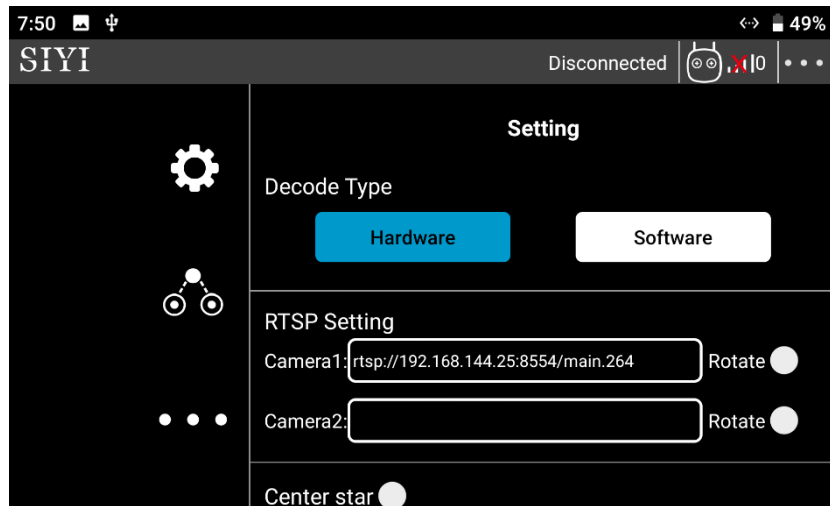

About Settings

Decoding Type: Switch between “Hardware Decoding” and “Software Decoding”. Please refer to your video input device to choose the decoding type with the best performance.

IP Addresses: Configure the IP address for camera A and camera B or for HDMI converter A and B. The “Rotate” buttons after the addresses can rotate the image in 180 degrees.

Cross Sight: Display a cross sight in the center of the image.

5.2 Link Status

Display the link status directly over the FPV image.

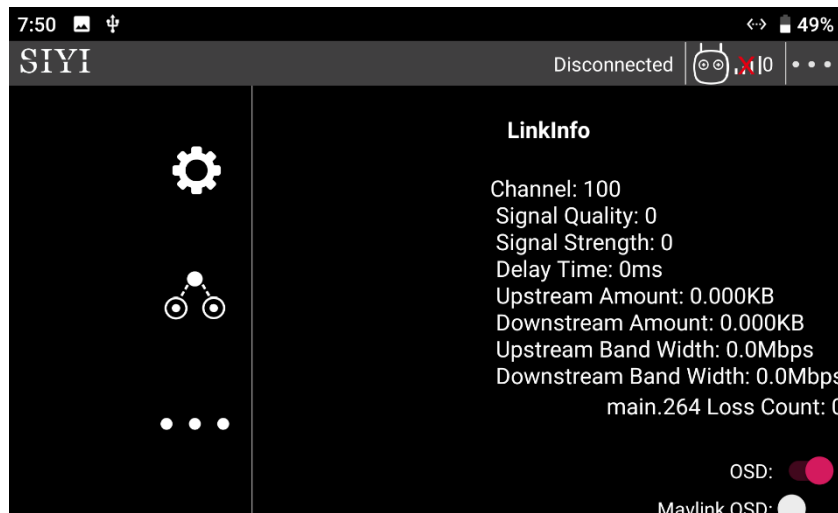

Mark

For details of Link Status, welcome to refer to Chapter 3.4 in this manual.

5.3 About SIYI FPV

Displays the software version of SIYI FPV and common contact information of SIYI Technology.

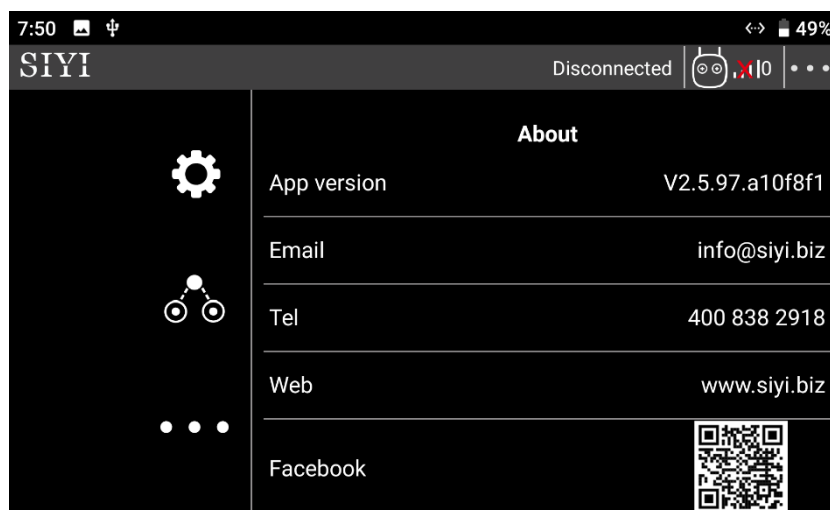

6 IMAGE TRANSMISSION

HM30 air unit supports maximum 1080p @ 60 fps and 150ms low-latency HD image transmission. It connects to most IP cameras and pods on market and can connect to HDMI cameras / pods through an HDMI input converter.

Then following steps will help you acquire image transmission display.

6.1 Using SIYI IP Cameras

Open SIYI FPV app, with the well-connected HM30 system you can check video display on your mobile device without any additional settings after powering on the system.

6.2 Using Third-Party IP Cameras / Pods

Before connecting a third-party camera or pod to the HM30 air unit, please change its IP address to “192.168.144.X”.

Mark

The “X” should not be “11”, “12”, or “20”, otherwise it won’t work. The three addresses have been occupied by the HM30 ground unit, the HM30 air unit, and the UDP network.

Let’s take QGroundControl as an example.

1. In camera settings, check and copy the RTSP addresses from your IP camera / pod.
2. In QGC, go to “General” page and slide to “Video Settings”.

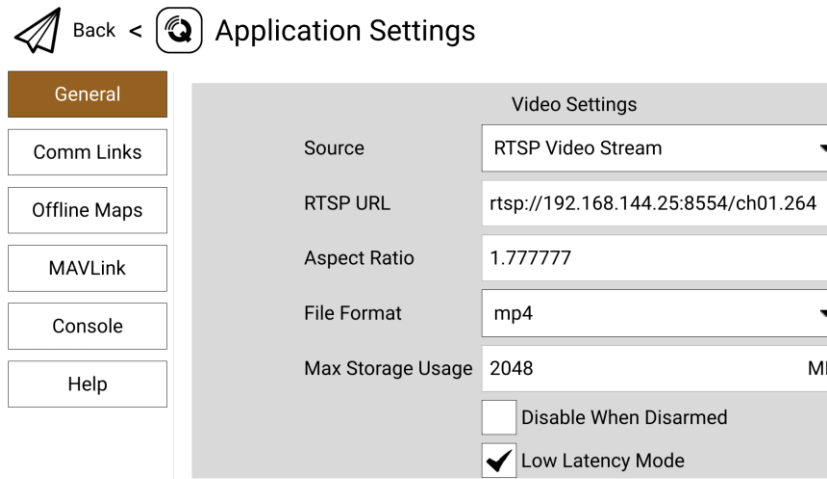

3. Configure “Source” as “RTSP Video Stream”. Then input the copied RTSP addresses of your IP camera / pod after the “RTSP URL”.
4. Go back to QGC home page to check video display.

6.3 Using HDMI Cameras / Pods

If you are using the SIYI original Air Unit HDMI Input Module to connect the HM30 air unit to your HDMI camera / pod, please refer to the steps below for acquiring video input.

Let’s take QGroundControl as an example.

1. Open QGC, go to “General” page and slide to “Video Settings”.
2. Configure “Source” as “RTSP Video Stream”. Then input the SIYI HDMI input module’s RTSP addresses after the “RTSP URL”.
3. Go back to QGC home page to check video display.

6.4 Dual Video Stream Connection

After connecting the FPV Hub to the HM30 air unit, dual video streams will work in many ways.

Mark

Dual video streams are recommended to multi-rotors commercial drone customers only.

When using dual video streams, please output video stream only from the Ethernet port (LAN) on HM30 ground unit. Through Type-C it only output one video stream. Outputting dual video streams through internal WiFi or USB WiFi could cause overheat in the ground unit and cause instability to the link.

6.4.1 Dual SIYI IP Cameras

The two SIYI IP Cameras should be Camera A and Camera B assigned with different IP addresses “192.168.144.25” and “192.168.144.26”. So, after connecting both cameras to the FPV Hub and opening SIYI FPV app, you can see dual video stream when the correct RTSP addresses are input in the IP addresses bars.

Mark

The SIYI IP Camera coming with HM30 FPV Combo and HM30 Fly More Combo or sold alone is default to be Camera A, of which the IP address is “192.168.144.25”. When you purchase another IP camera from SIYI for dual video streams, please make sure that you get

a Camera B (“192.168.144.26”).

Dual video stream does not work when the two streams use the same IP addresses.

6.4.2 Dual Third-Party IP Cameras

Make sure that the two IP cameras use different IP addresses and connect them to the FPV Hub. Then open SIYI FPV app, input the IP addresses in the bar and you will see two video streams.

6.4.3 SIYI HDMI Converter and SIYI IP Camera

The sold-alone Air Unit HDMI Input Module coming is default to be HDMI Converter A, of which the IP address is “192.168.144.25”. This IP has conflict to Camera A but no conflict to Camera B. When the dual video streams come from the same IP addresses, it won't work properly. Thus, please do ask your seller to make sure the IP addresses are different when you are to use more than one HDMI converter or IP camera.

When the IP addresses are different, and the cameras / HDMI converters are connected to the FPV Hub, input the IP addresses in the bars and you will see two video streams after opening SIYI FPV app.

6.4.4 SIYI HDMI Converter and Third-Party IP Camera

Make sure that the IP camera use a different IP address from the HDMI converter and connect them to the FPV Hub. Then open SIYI FPV app, input the IP addresses in the bar and you will see two video streams.

6.4.5 Dual SIYI HDMI Converter

The sold-alone Air Unit HDMI Input Module is default to be HDMI Converter A, of which the IP address is “192.168.144.25”. When you purchase another HDMI converter for dual video streams, please make sure that you get the HDMI Converter B (“192.168.144.26”).

Then, after connecting the two HDMI Converters in different IP addresses to the FPV Hub and opening SIYI FPV app, you can see dual video streams when the correct RTSP addresses are input in the IP address bars.

Mark

Dual video stream does not work when the two streams use the same IP address.

For more details about the IP addresses of the HM30 parts, please refer to the chapter 6.5 in this manual.

6.5 Common IP Addresses

HM30 Air Unit IP Address: 192.168.144.11

HM30 Ground Unit IP Address: 192.168.144.12

UDP Network IP Address: 192.168.144.20

SIYI IP Camera A's IP Address: 192.168.144.25

SIYI IP Camera B's IP Address: 192.168.144.26

SIYI HDMI Converter A's IP Address: 192.168.144.25

SIYI HDMI Converter B's IP Address: 192.168.144.26

SIYI IP Camera A's RTSP Address: rtsp://192.168.144.25:8554/main.264

or rtsp://192.168.144.25:8554/ch01.264

SIYI IP Camera B's RTSP Address: rtsp://192.168.144.26:8554/main.264

or rtsp://192.168.144.26:8554/ch01.264

SIYI HDMI Converter A's RTSP Address: rtsp://192.168.144.25:554/live/0

SIYI HDMI Converter B's RTSP Address: rtsp://192.168.144.26:554/live/0

Common Video Player: SIYI FPV, QGroundControl, EasyPlayer

Video Display URL: Please refer to the address given in camera settings. Cameras from different manufacturers come with different URL.

Network Diagnosis Tool: Ping Tools

Mark

Android mobile device can diagnose the video disconnection issue by pinging the IP addresses of different devices through the Ping Tools app.

Windows device can diagnose through its CMD program.

6.6 Output HM30 Ground Unit Video Stream

There are multiple ways to output video stream to other devices from HM30 ground unit.

6.6.1 Through Internal WiFi to Android Mobile Device

Let's take SIYI FPV as an example.

1. On HM30 ground unit, go to "Settings", set "Video Mode" as "Internal WiFi".
2. Turn on WiFi on your mobile device and search for the WiFi device starting with the ID "SIYI-6A*****" and pair. The password is "12345678".
3. Open SIYI FPV app and input the IP addresses of the SIYI IP Camera "rtsp://192.168.144.25:8554/main.264"

Mark

The IP addresses is default to be "rtsp://192.168.144.25:8554/main.264" when you open SIYI FPV app for the first time.

Before connecting a third-party IP camera to the HM30 air unit, please change its IP addresses to "192.168.144.X", otherwise the video stream won't be displayed properly.

6.6.2 Through USB WiFi to Android Mobile Device

Let's take SIYI FPV as an example.

1. Use the Type-C to USB-A cable to connect the USB WiFi module to the HM30 ground unit.
2. On HM30 ground unit, go to "Settings", set "Video Mode" as "USB WiFi".
3. Turn on WiFi on your mobile device and search for the WiFi device starting with the ID "SIYI-6A*****" and pair. The password is "12345678".
4. Open SIYI FPV app and input the IP addresses of the SIYI IP Camera "rtsp://192.168.144.25:8554/main.264"

Mark

The IP addresses is default to be "rtsp://192.168.144.25:8554/main.264" when you open SIYI FPV app for the first time.

Before connecting a third-party IP camera to the HM30 air unit, please change its IP addresses to "192.168.144.X", otherwise the video stream won't be displayed properly.

6.6.3 Through Type-C Port

Let's take SIYI FPV as an example.

1. On HM30 ground unit, go to "Settings", set "Video Mode" as "USB".
2. Use the original cable to connect your mobile device to the HM30 ground unit.
3. Turn on "USB Tethering" on your mobile device.

4. Open SIYI FPV app and input the IP addresses of the SIYI IP Camera
“rtsp://192.168.144.25:8554/main.264”

Mark

Before connecting a third-party IP camera to the HM30 air unit and outputting video stream through the Type-C port, please change its IP addresses to “192.168.144.25” and its gateway to “192.168.14.12”, otherwise the video stream won’t be displayed properly. Meanwhile, the network segment of the video player on either your mobile device or your Windows device should be changed to “192.168.42.1”.

6.6.4 Through LAN Port to Windows PC

Let’s take “Easy Player” as an example.

1. Use the “4-Pin to RJ45” cable to connect the RJ45 port on your Windows device to the Ethernet port (LAN) on HM30 ground unit.
2. Check the Windows device’s network settings and confirm if it can acquire IP addresses properly? And if the IP addresses are in the network segment “192.168.144.X”.
3. Install Easy Player and open it. Input the IP addresses of the SIYI IP Camera
“rtsp://192.168.144.25:8554/main.264”.



Mark

If the IP addresses configuration was failed, please refer to the picture below and do it manually.

<input checked="" type="radio"/> 使用下面的 IP 地址 (S):	
IP 地址 (I):	192 . 168 . 144 . 111
子网掩码 (M):	255 . 255 . 255 . 0
默认网关 (G):	192 . 168 . 144 . 12

6.6.5 Through the LAN Port and the HDMI Converter to HDMI Monitor

Let's take an example of outputting video stream from the ground unit to an HDMI monitor through the LAN port on HM30 ground unit and the Ground Unit HDMI Output Converter.

Diagram of HM30 Ground Unit HDMI Output Converter

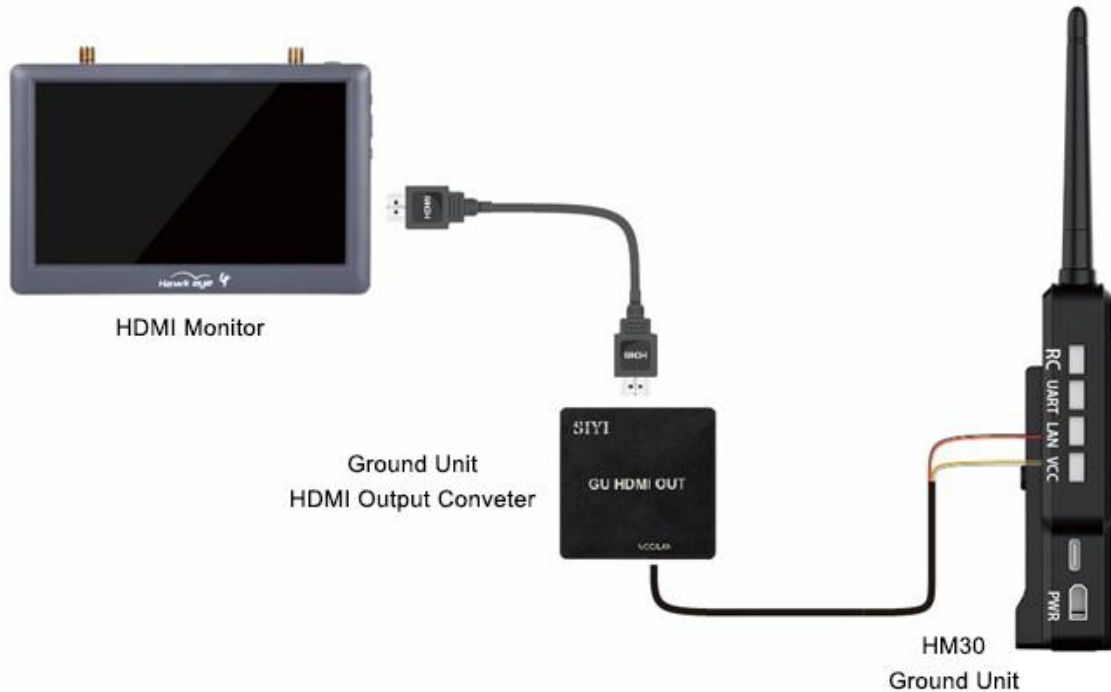

1. Use the power and signal cable for the HDMI output converter to connect the LAN port on HM30 ground unit and the VCC/LAN port on the converter.
2. Use the HDMI cable to connect the converter with the HDMI monitor.
3. Now power on HM30 and observe if the HDMI converter displays the image below (“FPV system is starting”) to check if the connection is successful.



4. If success, the HDMI monitor will display the video stream from the air unit after

binding with the ground unit.

Mark

If the HDMI monitor can display the FPV system's starting image but not the video stream, please observe the OSD information at top of the screen and check if it displays the signal quality, then please refer to the Chapter 6.7 in this manual and follow it step by step.

The image display latency could be high or the video may freeze if the HM30 ground unit is outputting video stream to multiple devices simultaneously.

Function Settings of the Ground Unit HDMI Output Converter

You can configure the below functions of the built-in FPV system for the HDMI Output converter when it is connected with a mouse and an HDMI monitor at the same time.

- Change IP addresses for the video stream to switch to a different camera.
- Switch the displayed unit of airspeed in the OSD information.
- Enable or disable Mavlink OSD display.
- Enable or disable longitude and latitude display.
- Other functions.

6.7 Solutions to No Image

If HM30 ground unit failed to output video or the video stream cannot be displayed properly, please follow the steps below to investigate possible reasons.

5. Confirm if the HM30 ground unit is bound with the HM30 air unit and confirm if the camera is connected to the air unit.
 - If the ground unit and air unit status indicators are Blue.
 - If the air unit FPV status indicator is orange.
6. Open “SIYI FPV” app and check if the IP addresses of the IP camera or the HDMI converter is correc. SIYI IP camera and HDMI converter have been labeled with their IP addresses before delivery. For third-party IP cameras, please refer to their camera settings.

If the video stream still does not display, please follow the steps below and make a deep investigation according to the video output mode and the video display device you use.

6.7.1 Video Output through WiFi and Display on A Mobile Device

1. On HM30 ground unit, go to “Settings” and check if the video output mode is “Internal WiFi” or “USB WiFi”.

2. Please confirm if the WiFi device is the internal WiFi in HM30 ground unit or a USB WiFi connected to HM30 ground unit.
3. Input the IP camera's IP addresses "192.168.144.25" in the "Ping Tools" app and check if the network communication is successful. If there is a response, then check if the RTSP address in the SIYI FPV app is correct.



Successful Network Communication

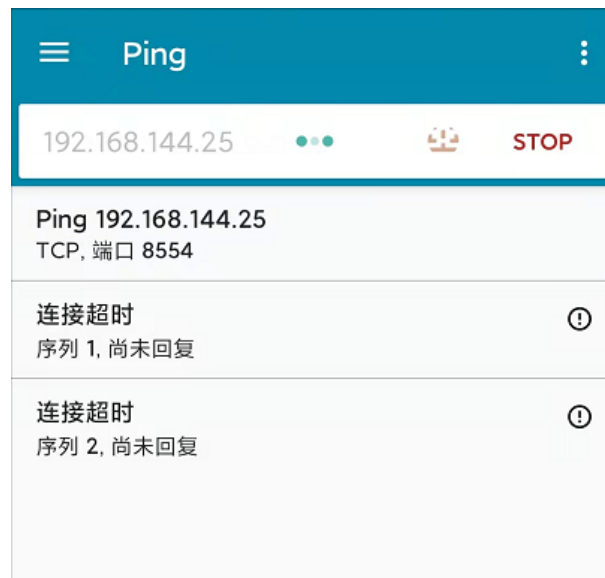

Network Communication Failed

4. If the network communication is failed, then input the IP addresses of the HM30 air unit into the “Ping Tools” app to check if the communication between the ground unit and the air unit is successful. If it is, then please check if the cable to connect the camera with the HM30 air unit is good, and the voltage input to the air unit’s XT30 port is between 11 V to 16.8 V.

Mark

Some Android mobile devices will disable WiFi transmission after detecting no data transferred through the WiFi link by the system. In such a case, please disable the cellular network and go back to step one to investigate again.

6.7.2 Video Output through USB and Display on A Mobile Device

1. On HM30 ground unit, go to “Settings” and check if the video output mode is “USB”.
2. After step 1, if there was no video display in SIYI FPV app, please plug in the Type-C cable to HM30 ground unit’s Type-C port again and check if the USB connection method is “File Transfer” on your mobile device.
3. If the SIYI FPV app can display the signal quality but still no video, please check if the RTSP addresses are correct (“rtsp://192.168.42.1:8554/main.264”).
4. Use the “Ping Tools” to input the IP camera’s IP addresses “192.168.144.25” and check if the network communication is successful. If the communication is failed, please input the HM30 air unit’s IP addresses “192.168.144.11” into the “Ping

Tools” app and check if the communication between the ground unit and the air unit is successful. If it is, then please check if the cable to connect the camera with the HM30 air unit is good, and the voltage input to the air unit’s XT30 port is between 11 V to 16.8 V.

6.7.3 Video Output through WiFi or LAN on A Windows Device

1. Use the “Win + R” key combo to wake up the “Run” program and input the command “cmd”.

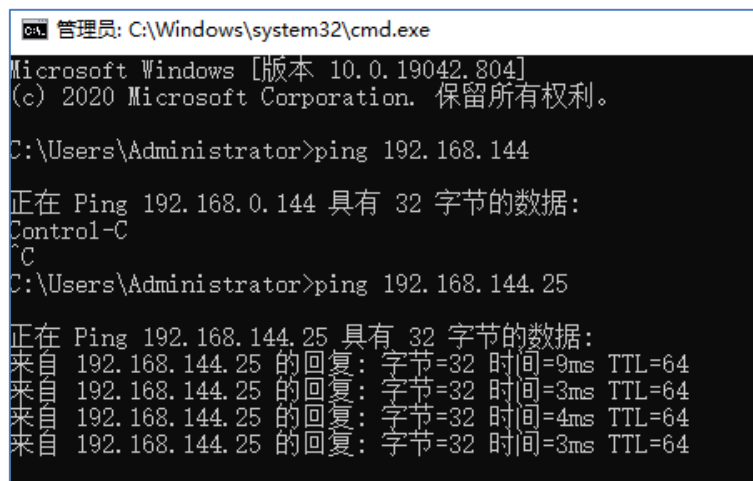

```
管理员: C:\Windows\system32\cmd.exe
Microsoft Windows [版本 10.0.19042.804]
(c) 2020 Microsoft Corporation. 保留所有权利。

C:\Users\Administrator>ping 192.168.144

正在 Ping 192.168.0.144 具有 32 字节的数据:
Control-C
^C
C:\Users\Administrator>ping 192.168.144.25

正在 Ping 192.168.144.25 具有 32 字节的数据:
来自 192.168.144.25 的回复: 字节=32 时间=9ms TTL=64
来自 192.168.144.25 的回复: 字节=32 时间=3ms TTL=64
来自 192.168.144.25 的回复: 字节=32 时间=4ms TTL=64
来自 192.168.144.25 的回复: 字节=32 时间=3ms TTL=64
```

Successful Network Communication

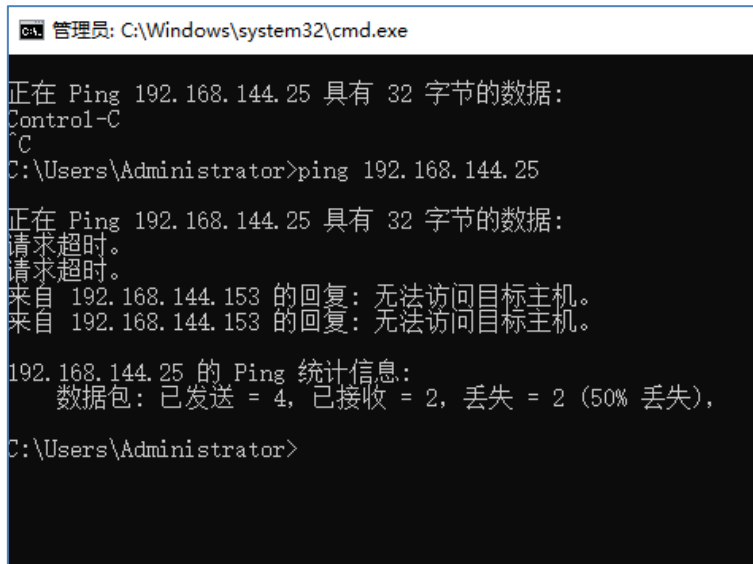

Network Communication Failed

2. Input the IP camera's IP addresses "192.168.144.25" and press the "Enter" key to check if the communication is successful. If it is successful, please check if the RTSP addresses in Easy Player is correct or try to switch to other video players.



3. If the communication is failed, please input the HM30 air unit's IP addresses "192.168.144.11" into the "Ping Tools" app and check if the communication between the ground unit and the air unit is successful. If it is, then please check

if the cable to connect the camera with the HM30 air unit is good, and the voltage input to the air unit's XT30 port is between 11 V to 16.8 V.

4. If the communication is still failed, then please input the HM30 ground unit's IP addresses "192.168.144.12" and check if the communication between the ground unit and the Windows device is successful. If it isn't, please check the network of the Windows device is good? And if the network settings can acquire IP addresses normally. You can also refer to the picture below to configure them manually.

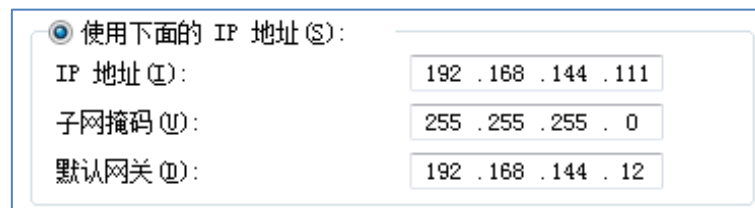

The image shows a network configuration window with the following fields:

<input checked="" type="radio"/> 使用下面的 IP 地址(S):	
IP 地址(I):	192 . 168 . 144 . 111
子网掩码(M):	255 . 255 . 255 . 0
默认网关(G):	192 . 168 . 144 . 12

Mark

If you have done investigation by following all steps above, but the reason is still not located, please contact your dealer or contact SIYI Support immediately.

7 Firmware Upgrade

7.1 HM30 RF Firmware Upgrade

HM30 ground unit and HM30 air unit support firmware upgrading through PC software.

Before upgrading, it is necessary to prepare the tools, software, and firmware below.

- SIYI Assistant (PC Software)
- HM30 Ground Unit RF Firmware
- HM30 Air Unit RF Firmware

Mark

Above software and firmware can be downloaded from SIYI Official website or downloaded from SIYI HM30 Google Drive (<https://drive.google.com/drive/folders/1dN6xjTmUncQ-8LZRCVpfNUR6SEq4XbTr?usp=sharing>) or got from your dealer.

- Fast Charging Cable (Type-C to Type-C)
- Converter (Type-C to USB)

Mark

Above tools come with the HM30 package.

Fast charging cable and converter can be used to upgrade HM30 air unit and ground unit firmware.

Firmware Upgrade Steps

1. Install “SIYI Assistant” into your Windows device.
2. Connect the fast-charging cable to the Windows device’s USB port and the HM30 ground unit’s Type-C port.
3. Run “SIYI Assistant” and switch to “Upgrade” page to check the HM30 ground unit’s current RF firmware version.
4. If the HM30 ground unit’s firmware is not the latest, then click the “Select File” button after “RC” line to import the latest ground unit’s RF firmware. Then click “Upgrade” and wait till it is “100%” finished.
5. Disconnect the HM30 ground unit your Windows device and connect the HM30 air unit to it. Then repeat above steps to upgrade the air unit’s RF firmware.

7.2 Upgrade HM30 Ground Unit HDMI Output Converter's Built-in FPV System

The build-in FPV system of the HM30 ground unit HDMI output converter can be upgraded by connecting a mouse and an USB disk at the same time.

Before upgrading, it is necessary to prepare the tools, software, and firmware below.

- USB Upgrade Cable (Dual USB-A Female Head)

Mark

The above tool comes with the HM30 Ground Unit HDMI Output Converter in package.

- SIYI FPV App

Mark

The above software can be downloaded from SIYI Official website or downloaded from SIYI HM30 Google Drive (<https://drive.google.com/drive/folders/1dN6xjTmUncQ-8LZRCVpfNUr6SEq4XbTr?usp=sharing>) or got from your dealer.

- USB Disk (with the latest version of the SIYI FPV app stored)

- Mouse

Firmware Upgrade Steps

1. Connect the mouse and the USB disk with the USB upgrade cable.
2. The built-in FPV system inside the HDMI output converter will open the file manager automatically when the system is starting.
3. Click the SIYI FPV app in the USB disk and install.
4. After installation, please check the SIYI FPV app version to confirm if the upgrade is successful.
5. Plug out the USB upgrade cable and restart HM30.

8 After-sale Service

If there were any questions or problems using SIYI Technology's product, you can always try to send an email to SIYI Official A/S Center (support@siyi.biz) or consult your sales representative or dealer for answers or solutions.

8.1 Repair Service

If your purchased SIYI products cannot work properly, please contact SIYI Official A/S Center for consulting.

Usually there are two situations for acquiring repair service.

- Product Defect
- Product Damage

SIYI products under the two situations can be sent back to SIYI for repairing. Defect products with valid warranty can be repaired for free. Defect products without valid warranty or damaged products should be charged of repair fees after repairing. Please refer to SIYI's Official A/S Quotation for detail.

8.2 Warranty

SIYI Technology guarantees that, subject to the following conditions, Return & Refund Service, Replacement Service, and Warranty Repair Service can be requested. Please contact SIYI directly (support@siyi.biz or your sales manager) or authorized SIYI dealer for more detail.

8.2.1 7-Day Return & Refund

You can request Return & Refund Service:

Within seven (7) days of receiving a product if the product has no manufacturing defect, has not been activated and is still in new or like-new condition.

Within seven (7) days of receiving a product if the product has a manufacturing defect.

Return & Refund Service will not be provided where:

It is requested beyond seven (7) calendar days of receiving a product.

A product sent to SIYI for Return & Refund Service does not include all original accessories, attachments or packaging, or any item is not in new or like-new condition, i.e., with cracks, dents, or scratches.

A legal proof of purchase, receipt or invoice is not provided or is reasonably believed to have been forged or tampered with.

Any fault or damage of the product is caused by unauthorized use or modification of the product, including exposure to moisture, entry of foreign bodies (water, oil, sand, etc.) or improper installation or operation.

Product labels, serial numbers, waterproof marks, etc. show signs of tampering or alteration.

Damage is caused to the product by uncontrollable external factors, including fire, floods, high winds, or lightning strikes.

A product is not delivered to SIYI within seven (7) calendar days after Return & Refund Service confirmation is sent from SIYI.

Other circumstances stated in this policy.

8.2.2 15-Day Replacement

You can request Replacement Service:

Within fifteen (15) calendar days of receiving the product if the product has sustained a substantial damage in transit, provided always that the damage proof issued by the carrier can be provided to SIYI.

Within fifteen (15) calendar days of receiving the product if the product does not match the original description of the product in one or more significant respects.

Within fifteen (15) calendar days of receiving the product if the product suffers performance failure.

Replacement Service will not be provided where:

Service is requested more than fifteen (15) calendars days after receiving a product.

Legal proof-of-purchase, receipts, or invoices are not provided, or are reasonably believed to have been forged or tampered with.

A product sent to SIYI for replacement does not include all original accessories, attachments, and packaging, or contains items damaged by user error.

A product is found to have no defects after all appropriate tests are conducted by SIYI.

Any fault or damage of the product is caused by unauthorized use or modification of the product, including exposure to moisture, entry of foreign bodies (water, oil, sand, etc.) or improper installation or operation.

Damage is caused by uncontrollable external factors, including fires, floods, high winds, or lightning strikes.

Received product has not been sent back to DJI seven (7) calendar days after replacement confirmation from DJI.

Proof of damage during transit issued by the carrier cannot be provided.

Other circumstances stated in this policy.

8.2.3 1-Year Warranty Repair

You can request warranty repair service:

If a product does not function as warranted during the warranty period, you may obtain after-sales service by contacting SIYI's service center. You will need to provide a valid proof-of-purchase, receipt, or order number for the warranty service.

Charges may apply for services not covered by this Limited Warranty. Please contact SIYI for information specific to your location.

Please note that the warranty service is only available in the respective SIYI service regions where you purchased your SIYI product.

Warranty Repair service will not be provided where:

Crashes or fire damage caused by non-manufacturing factors, including but not limited to pilot errors.

Damage caused by unauthorized modification, disassembly, or shell opening not in accordance with official instructions or manuals.

Damage caused by improper installation, in correct use, or operation not in accordance with official instructions or manuals.

Damage caused by non-authorized service provider.

Damage caused by unauthorized modification of circuits and mismatch or misuse of the battery and charger.

Damage caused by operation in bad weather (i.e., strong winds, rain, sand/dust storms, etc.)

Damage caused by operating the product in an environment with electromagnetic interference (i.e., in mining areas or close to radio transmission towers, high-voltage wires, substations, etc.)

Damage caused by operating the product in an environment suffering from interference from other wireless devices (i.e., transmitter, video-downlink, Wi-Fi signals, etc.)

Damage caused by reliability or compatibility issues when using unauthorized third-party parts.

Damage caused by operating the unit with a low-charged or defective battery.

Products or parts with an altered identification label or from which the identification label has been removed.

SIYI Technology (Shenzhen) Co., Ltd

Business Inquiry: info@siyi.biz

Phone: +86 400 838 2918

A/S Center: support@siyi.biz