



GM65 Bar Code Reader Module User Manual



Hangzhou Grow Technology Co., Ltd.
V1.7 Sept. 2021

Catalog

1. Introduction of Module.....	3
1.1 Introduction.....	3
1.2 Technical Specification.....	3
1.3 Dimension(mm).....	2
1.4 Circuit Board Communication Interface.....	4
1.5 Readable Barcode Type.....	5
1.6 Setup Code.....	5
1.7 Save and Cancel.....	6
1.8 Reset.....	6
2 Communication interface.....	7
2.1 Series Communication Interface.....	7
2.1.1 Serial Port Check Bit Configuration.....	8
2.1.2 Serial Port and Full Code Open Shortcut Configuration.....	8
2.2 USB HID Interface.....	9
2.2.1 HID Type Device Selection.....	9
2.2.2 HID Parameter Configuration.....	9
2.2.3 HID Lead Key Output.....	11
2.2.4 HID KBW Serial Output at the Same Time.....	11
2.2.5 HIDPOS HIDKBW Output at the Same Time.....	11
2.3 USB Virtual Serial Port.....	11
3 Read Mode.....	12
3.1 Continuous Mode.....	12
3.2 Induction Mode.....	13
3.3 Manual Mode.....	15
3.4 Command Triggered Mode.....	16
3.5 POS Mode.....	17
4 Read area.....	18
4.1 Full Width Area.....	18
4.2 Central Area only.....	18
5 Lighting and Collimate.....	20
5.1 Lighting.....	20
5.2 Collimation.....	20
6 Prompts.....	21
6.1 Prompts Tone.....	21
6.2 Read code successfully tone.....	22
6.3 Data code format.....	22
6.4 Keyboard Settlement.....	23
6.5 Virtual keyboard Allow.....	24
6.6 Image Flip.....	24
6.7 Black and White Flip.....	25
7 Data Edition.....	26
7.1 Prefix.....	26

7.2 Suffix.....	27
7.3 CODE ID.....	27
7.4 Tail.....	30
7.5 Cut out Data.....	30
7.6 RF Information.....	32
7.7 Output Protocol.....	33
7.8 UPCA convert to EAN13.....	33
7.9 Commodity Code Check Output.....	33
8 Bar code type enables/disable configuration.....	34
8.1 All types of bar code can be decoded.....	34
8.2 Strengthen the Reading Ability.....	34
8.3 EAN13.....	34
8.4 EAN8.....	35
8.5 UPCA.....	35
8.6 UPCEO.....	36
8.7 UPCE1.....	36
8.8 Code128.....	37
8.9 Code39.....	37
8.10 Code93.....	38
8.11 CodeBar.....	39
8.12 QR.....	39
8.13 Interleaved 2 of 5.....	40
8.14 Industrial 25.....	40
8.15 Matrix 2 of 5.....	41
8.16 Code11.....	41
8.17 MSI.....	42
8.18 RS.....	43
8.19 DM.....	43
8.20 PDF417.....	44
9 Serial Port Instruction.....	45
9.1 CRC Algorithm.....	45
9.2 Read Zone Bit.....	46
9.3 Write Zone Bit.....	47
9.4 Save Zone Bit To Internal Flash Instruction.....	49
9.5 Zone Bit Reset To Defaults.....	50
9.6 Program Erasure Operation.....	50
9.7 List of zone bit.....	52
10 Appendix A: Common serial port instruction.....	63
11 Appendix B: Common serial port instruction.....	64
12 Appendix C: Code ID List.....	65
13 Appendix D: ASCII.....	66
14 Appendix E: Data code.....	70
15 Appendix F: Save or Cancel.....	72

1. Introduction of Module

1.1 Introduction

GM65 Bar code reader module is a high performance scanner, can read 1D bar code easily and read 2D bar code with high speed. It also wins high scan speed for linear code, even for bar code on paper or screen.

GM65 bar code reader module is an advanced bar code decoding algorithm which developed on image recognition algorithm, can easily and accurately read bar code, simplify secondary development.

GM65 works stable in dark and large temperature range.



1.2 Technical Specification

Default scan mode		Continuous scan	
Read code time for once		3s	Parameter: 0.1-25.5s; step-size: 0.1s; 0 means no time limited
Reading interval		1S	Parameter: 0.1-25.5s; step-size: 0.1s; 0 means no time limited
Output		GBK	GBK、UNICODE、BIG5
Interface		USB	USB 、UART、USB VCom
Interface (TTL-232)	Serial Baud Rate	9600	adjustable, details at 2.1
	Verification	N	
	Data bit	8	
	Stop bit	1	
	CTSRTS	No	
serial mode	Read code time for once	5s	Parameter: 0.1-25.5s; step-size: 0.1s; 0 means no time limited

Electrical specification:

1	Operating Voltage	DC 4.2 - 6.0V
2	Standby Current	30mA
3	Operating Current	160mA
4	Sleep Current	3mA

Running characteristic

1	Light	White light
2	Capture light	Red
3	Scan Angle	Roll:0-360° , Pitch:±65° , Yaw:±60°
4	Resolution	648x 488
5	Scanning angle	35° (Inclination) , 28° (Elevation)

1.3 Dimension(mm)

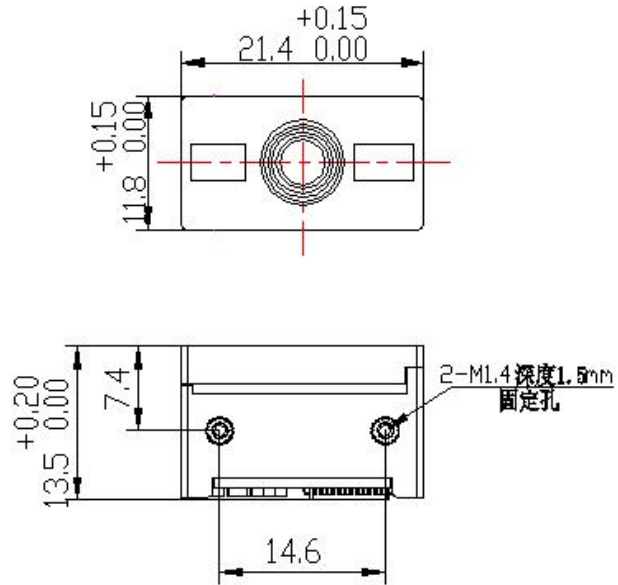

Control Panel

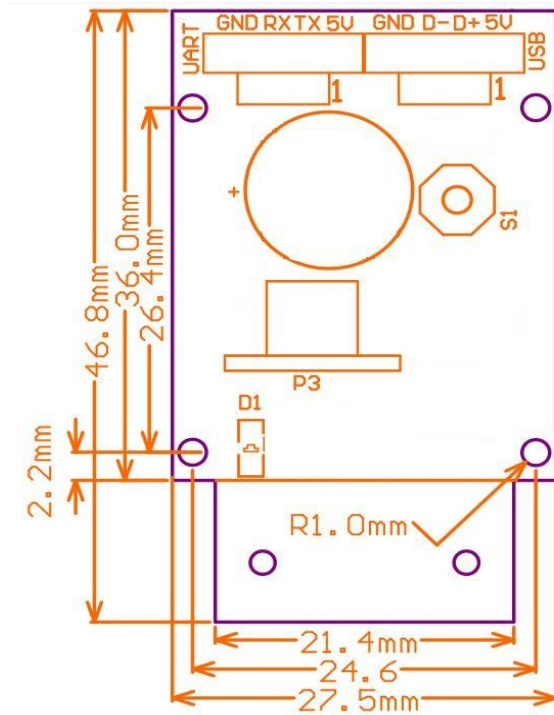

Scan Area (testing in office (250 lux))

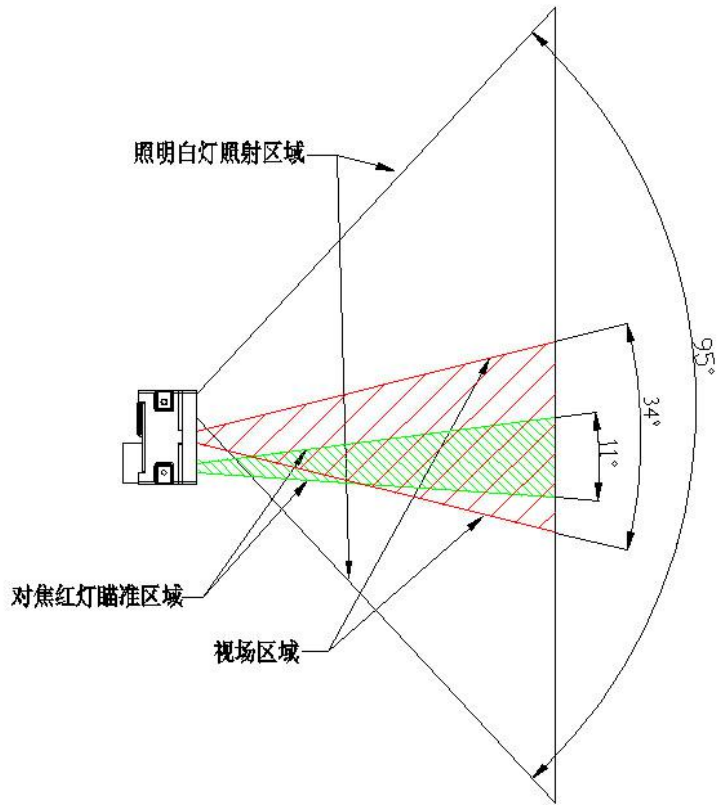

Type of Bar Code	Density	Min. distance	Max. distance
Code 39	0.125 mm (5 mils)	4.0 cm	9.0 cm
	0.375 mm (15 mils)	4.0 cm	25.0cm
UPC/EAN	0.375 mm (15 mils)	4.0 cm	25.0cm
Code93	0.254 mm (10 mils)	4.0 cm	21.0cm

1.4 Circuit Board Communication Interface

UART Communication interface definition:

Pin	Name	Definition	Description
1	5V	Power Input	Power input 5V
2	TX	Out	Data output. TTL logical level
3	RX	In	Data input. TTL logical level
4	GND	-	Signal ground

USB Communication interface definition:

Pin	Name	Definition	Description
1	5V	Power Input	Power input 5V
2	D+	Out	USB data output
3	D-	In	USB data input
4	GND	-	Signal ground

1.5 Readable Barcode Type

	Readable	Default Readable
Codabar	✓	✓
Code 11	✓	×
Code 39/Code 93	✓	✓
UPC/EAN	✓	✓
Code 128/EAN128	✓	✓
Interleaved 2 of 5	✓	×
Matrix 2 of 5	✓	×
MSI Code	✓	×
Industrial 2 of 5	✓	×
GS1 Databar	✓	✓
QR code	✓	✓
Data Matrix	✓	✓
PDF417	✓	✓

1.6 Setup Code

Customer can set module by scan setup code.



Default: setup code on



Off

Output details in setup code



Default: Not output



Output

1.7 Save and Cancel

Scan cancel code to cancel wrong read date.



Save



Cancel all read bytes



Cancel last byte



Cancel changes

1.8 Reset

Back to Factory Setting by scan follow code.



Reset

2 Communication interface

GM65 can receive database, control module and set functional parameter by TTL - 232.

2.1 Series Communication Interface

It's default and common to connect module and mainframe(such as PC, POS) by series communication interface. Make sure communication parameter for module and mainframe are same, then it will communicate smooth and correctly.



Series Output

TTL-232 is used for series interface which suitable for most system. Required change-over circuit for RS-232.

Default Parameter as formForm 2- 1. Only Baud Rate can be changed.

Form 2-1 Default Parameters

Parameters	Default
Series communication interface	Standard TTL-232
Baud rate	9600
Verification	N
Data bit	8
Stop bit	1
CTSRTS	N

Baud Rate Settlement



1200bps



4800bps



9600bps(Default)



14400bps



19200bps



38400bps



57600bps



115200bps

2.1.1 Serial Port Check Bit Configuration

Modify the parity bit of the serial port by scanning the following configuration code.



*NONE



ODD



EVEN

2.1.2 Serial Port and Full Code Open Shortcut Configuration



Serial Port and Full Code Open Shortcut

2.2 USB HID Interface

Scan the following code to become HID device when module connects PC by USB.



***USB HID device**

2.2.1 HID Type Device Selection

When the device is a HID type device, it can be 2 different types of devices.



***HIDKBW**



HIDPOS

2.2.2 HID Parameter Configuration

Scan the following code to modify the PC access cycle for HID devices.



***1ms**



3ms



5ms



10ms

Modify the interval between the device from a valid message to a released message by scanning the following setup code.



***0ms**



1ms



5ms



10ms



15ms

Modify the interval between the device from releasing message to the next valid message by scanning the following setup code.



***0ms**



1ms



5ms



10ms



15ms

Modify the state of the CapsLock when it prints by scanning the following setup code.



***Off**



On

2.2.3 HID Lead Key Output

By scanning the following setup code to make HID output a leading message before each segment of data, so as to facilitate customer software development and positioning. The key value is ctrl+shift+r.



*HID leading Forbid



Allow

2.2.4 HID KBW Serial Output at the Same Time

By scanning the following setup code,while HID KBW is output, data is output through serial port.



*Forbid



Allow

2.2.5 HIDPOS HIDKBW Output at the Same Time

By scanning the following setup code to enable HIDKBW data output while HIDPOS output.



*Forbid



Allow

2.3 USB Virtual Serial Port

Scan the following code to become virtual serial port output pattern when module connects PC by USB.



USB Virtual serial port

3 Read Mode

3.1 Continuous Mode

On this mode, reading module read code continuous and automatic.

Break after reading one code, break time is changeable.

Click the toggle key to pause. Then click to continuous cyclic read code.



Default Continuous Mode

Time settlement for single read

The longest time before first successful reading. After this time, module will be into no read time.

Single Read time: 0.1~25.5 s, step-size: 0.1s;

0 means infinite time interval.

Default time: 5s



1000ms



5000ms



default 3000ms



infinite time interval

Break time settlement

Time between two read. Can be settled from 1 to 25.5 s, step-size: 0.1s; default 1.0s



No break



500ms



default 1000ms



1500ms



2000ms

Same barcode reading delay

The same barcode reading delay refers to that after the module reads the same bar code, it will be compared with the last reading time,when the interval is longer than the reading delay, the same barcode is allowed to be read, otherwise the output is not allowed.



Same barcode reading delay



*Same bar code reading without delay

Same barcode reading delay time

When the same barcode reading delay is enabled,scan the following code to set same barcode reading delay time.



Infinite delay



500ms



1000ms



3000ms



5000m

3.2 Induction Mode

After setting, module begins to monitor brightness immediately. When scene changed, module will begin to read until time of image stabilization over.

After first successful reading or single reading time out, module will monitor brightness again after some time (changeable)

Module will cycle working as above when follow happen: module can't find code between single read time, then it will stop reading and jump to monitor brightness.

On induction mode, module can begin reading code by click, and it will begin to monitor brightness when release toggle key or successfully output information.



Induction Mode

Time settlement for single read

The longest time read before first successful reading. After this time, module will be into no read time.

Single Read time: 0.1~25.5 s, step-size: 0.1s;

0 means infinite time interval.

Default time: 5s



1000ms



3000ms



Default 5000ms



infinite time interval

Break time settlement

After one successful output or time out for single read. Module will be into monitor after some time.

Time from 0 to 25.5 s, step-size: 0.1s; default 1.0s



No Break



500ms



Default 1000ms



1500ms



2000ms

Image stabilization time

Image stabilization time: the time cost after module find scene change then waiting for the scene stable. Time from 0s to 25.5s, step size 0.1s. Default 0.4s.



*0ms



100ms



400ms



1000ms



2000ms

Sensitivity

Detect the degree of change in the scene in inductive reading mode. When the reading module judges that the scene change degree meets the requirements, it will switch from the monitoring state to the reading state.



*Ordinary sensitivity



Low sensitivity



High sensitivity



Extra high sensitivity

Same barcode reading delay

The setup code is the same as in **Continuous Mode**.

3.3 Manual Mode

Manual mode is default mode. Click toggle key begin to read, stop when output or release toggle key



Manual Mode

Scan the following code to configuration edge trigger or level trigger.



*Level Trigger



Edge Trigger

Into sleep mode after not work for a while, can be settled by following code.



Sleep mode on



Sleep mode off

Come into sleep mode, can wake up by key. Module will restart after dropping out sleep mode.

When deep sleep is not enabled, you can set the idle time for light sleep by scanning the following Settings.



0ms



*500ms



3000ms



5000ms

3.4 Command Triggered Mode

Module begins to read when receive scan command from mainframe(bit0 of zone bit 0x0002 writes"1") , and stop at output or read timeout.



Command triggered mode

Under command triggered mode, command for serial port trigger is 7E 00 08 01 00 02 01 AB CD;
After receiving command, model will output “ 02 00 00 01 00 33 31” and start scan.

Time settlement for single read

Read and Scan time before output. From 0.1s to 25.5s, step size 0.1s. 0 : infinite time interval;

Default: 5s



1000ms



3000ms



Default 5000ms



infinite time interval

3.5 POS Mode

Users can quickly configure the module to work in POS mode by scanning the following code.

Including the following main features:

- Read mode is command trigger mode
- The communication interface is serial port
- Turn off startup tone
- Turn off ending character



POS Mode

4 Read area

4.1 Full Width Area

When the read area is a full-width area, the module will scan the barcode around with the center as the priority, and the barcode can be located at any position of the screen.



*Full Width Area

4.2 Central Area only

When the reading area is the central area, the central position of the barcode must be in the central area set. Bar codes are not within the scope of the region are not identified and output.



Central Area only

Set the size of the central area:

The central area is an area with the center of the whole image as the central point. The size of this area is set in proportion to the width or height of the whole image, and the value range is 1-100. If set to 20, it is located in an area 20% of the width * 20% of the height of the center.

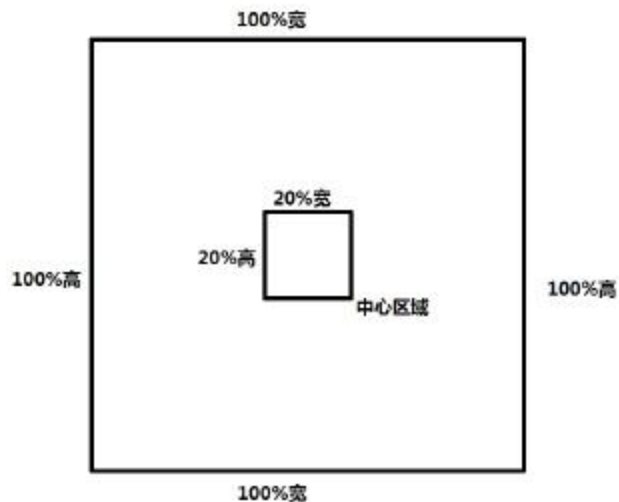

Modify the central area size

The common central area size can be set by scanning the following code:



central area size-20%



central area size-40%



central area size-60%

When the common central area size does not meet the needs, users can also scan the "modify the central area size" setting code to customize the configuration.



modify the central area size

Example: change the center area size to 50%

1. Check the character table to get the hexadecimal value of "50" characters: "32"
2. Confirm whether the setting code is on or not. If it is off, please scan the "open setting code" setting code (see section 1.4).
3. Scan the setting code of "modify the size of central area"
4. Scan data setting codes "3" and "2" successively (see appendix E)
5. Scan "save" setting code (see appendix F)

5 Lighting and Collimate

5.1 Lighting

Head lamp is used to additional lighting when read.

Normal(default): Head lamp will be on when read, others off.

Normally on: always on after boot.

OFF: head lamp is always off



Normal



Normally on



Off

5.2 Collimation

There will be a pointing light beam which can help user to find best distance.

Normal(default): pointing light beam shows when read

Normally on: pointing light beam shows after power on until power off

No Collimation: no pointing light beam



Normal(default)



Normally on



No Collimation

6 Prompts

6.1 Prompts Tone

Read "buzzer drive frequency", the buzzer can be set to active/passive buzzer, the drive frequency of the passive buzzer can also be set.



Buzzer drive frequency-passive low frequency



***Buzzer drive frequency-passive medium frequency**



Buzzer drive frequency-passive high frequency



Buzzer drive frequency - active drive

In the active buzzer mode, scan "Buzzer working level - high" can be set to low level when free, high level when busy; scan "Buzzer working level - low" can be set to high level when free, low level when busy.



***Buzzer working level - high**



Buzzer working level - low

Scan "Open Start-up tone" can open start-up tone. Scan "Close Start-up tone" can close start-up tone.



***Open Start-up tone**



Close Start-up tone

Silence: Close all prompt tones



Silence on



*Silence off

6.2 Read code successfully tone



Default on



Close read code successfully tone

Duration time setting. Default: 60ms



30ms



*60ms



90ms



120ms

6.3 Data code format

Read following to enable the reading module to read the Chinese barcode of various encoding format.



Input Data code format GBK



Input Data code format UTF8



*Input Data code format AUTO

Read following to print Chinese data according to specified code format.

GBK format: notepad, UNICODE format: WORD and input box for chat tools



***Output Data code format GBK**



Output Data code format UTF8

6.4 Keyboard Settlement

Scan following code to change keyboard.



Default Keyboard- US



Czech



France



Germany



Hungary



Italy



Japan



Spain



Turkey-F



Turkey-Q

6.5 Virtual keyboard Allow

In order to be able to use in more areas, we also provide the virtual keyboard function, so that the virtual keyboard can be output in any keyboard mode, but it will relatively lose some output efficiency. In addition, when using a virtual keyboard, you must ensure that the numeric keys on the keypad are valid. Note that the virtual keyboard must be available at version 1.21 or above.



*Standard keyboard



Virtual keyboard

In order to adapt to different application scenarios, the virtual keyboard has two different output modes for control characters smaller than 0x20, and the user can switch by scanning the following code.



Ctrl Mode



*Alt Mode

6.6 Image Flip

When meet flipped or mirror image, like:



原始图像



镜像翻转

Scan code into or exit image flip mode



image flip mode



Exit

PS: in the image flip mode can only scan flipped image. For normal, should exit.

6.7 Black and White Flip



* One-dimensional barcode forbidden anti-color decoding



Allow



* Two-dimensional barcode forbidden anti-color decoding



Allow

7 Data Edition

Sometimes we need to edit the data before output to make data separation and processing more easily.

Data edition include:

- Add Prefix
- Add Suffix
- Cut data
- Output CodeID
- Output “RF” when fail to decode
- Add End words”Tail”

Output sequence after data edition:

【Prefix】【CodeID】【Data】【Suffix】【Tail】

7.1 Prefix

Add prefix

Prefix is on the head of encoding Information , and can be self-defined.

Scan the code to add prefix.



Allow to add prefix



Default no prefix

Change prefix

Scan “change prefix” and “setup code” code to change prefix.

Use 2 base 16 to express each character.

Max 15 characters.

ASCII on appendix D.



change prefix

E.G. Change prefix to “DATA”

1. “DTAT” in base 16: “44”, “41”, “54”, “41”
2. Confirm open the “ setup code”, if not, find on 1.4
3. Scan “change prefix” code
4. Successively scan “Code ID”: “4”, “4”, “4”, “1”, “5”, “4”, “4”, “1”

7.2 Suffix**Add Suffix**

Suffix on the end of encoding Information, and can be self-defined.

**Allow add suffix****Default no suffix****Change suffix**

Scan “ change suffix” and “setup code” code to change prefix.

Use base 16 to express each character.

Max 15 characters. ASCII on appendix D.

**Change Suffix****E.G.: Change suffix to “DATA”**

1. “DTAT” in base 16: “44”, “41”, “54”, “41”
2. Confirm opening the “setup code”, if not, find on 1.4
3. Scan “change suffix” code
4. Successively scan “Code ID”: “4”, “4”, “4”, “1”, “5”, “4”, “4”, “1”
5. Scan “save” code

7.3 CODE ID**Add CODE ID**

Users can identify different types of bar code by CODE ID. CODE ID use one character to identify and can be self- defined.



Allow add CODE ID



Default close CODE ID

Default of CODE ID

Scan “ Default of CODE ID” to back default ID, default ID on appendix C



all bar code back to default ID

Change CODE ID

Users can change CODE ID of any bar code by scan the setup code (as follow) and data edition code.

Base 16 is used to express each CODE ID.

ASCII on appendix D.

E.G.: change CODE ID of CODE 128 to “A”

1. Find “A”=”41” in base 16
2. Confirm opening the “setup code”, if not, find on 1.4
3. Scan “ change CODE 128”
4. Successively scan “Code ID”: “4”, “1”
5. Scan “save” code

Change CODE ID LIST



Change CODE ID of EAN13



Change CODE ID of EAN8



Change CODE ID of UPCA



Change CODE ID of UPCE0



Change CODE ID of UPCE1



Change CODE ID of CODE 128



Change CODE ID of CODE 39



Change CODE ID of CODE 93



Change CODE ID of CODE BAR



Change CODE ID of Interleaved 2 of 5



Change CODE ID of Industrial 25



Change CODE ID of Matrix 2 of 5



Change CODE ID of CODE 11



Change CODE ID of MSI



Change CODE ID of RSS



Change CODE ID of limited RSS



Change CODE ID of expended RSS



Change CODE ID of QR CODE



Change CODE ID of Data Matrix



Change CODE ID of limited PDF417

7.4 Tail

Open this function to help system quickly distinguish current decoding results.

Scan “Add tail” to open this function, if read success, there will be tail on the end of decode data.



Close tail



*Add tail “CR”



Add tail “TAB”



Add tail “CRLF”

7.5 Cut out Data

Open to output part of data.

[Data] is composed of [Start] + [Center] + [End]

Character length of “start” and “end” can be changed



*Output whole data



Output Start part



Output End Part



Output Center part

Change length of [Start]-M

Scan “ Change M” code and “data edition” code to change length of [Start], max 255 characters

Base 16 is used to express length. ASCII on appendix D.



Change M

Change length of [End]-N

Scan “ Change N” code and “data edition” code to change length of [Start], max 255 characters

Base 16 is used to express length. ASCII on appendix D.



Change N

Output Start part

E.G. Output “1234567890123” of whole decode information “ 1234567890123ABC”

1. “13” =”0D” in base 16
2. Confirm opening the “setup code”, if not, find on 1.4
3. Scan” change length M”
4. Successively scan “Code ID”: “0”, “D”
5. Scan “save” code
6. Scan” Output Start part”

Output End Part

E.G. Output “ABC” of whole decode information “ 1234567890123ABC”

1. “3” = “03” in base 16
2. Confirm opening the “setup code” , if not, find on 1.4
3. Scan ”change length N”
4. Successively scan “Code ID”:”0”, “3”
5. Scan “save” code
6. Scan” Output Start part”

Output Center part

E.G.: Output “0123” of whole decode information “1234567890123ABC”

1. “10” = “0A”; “3” = “03” in base16
2. Confirm opening the “setup code”, if not, find on 1.4
3. Scan “change length N”
4. Successively scan “Code ID”: “0”, “3”
5. Scan “save” code
6. Scan “change length M”
7. Successively scan “Code ID”: “0”, “A”
8. Scan “save” code
9. Scan “Output Center part”

7.6 RF Information

RF(Read Fail): Users can self-define output information when read fail.



Output RF information



Default not output

Change RF information

Scan “change RF information” and “data edition code” to change RF information.

Base 16 is used to express, max at 15 character. ASCII on appendix D.



Change RF information

E.G.: change RF to “FAIL”

1. Find “FAIL” in base-16: “46”, “41”, “49”, “4C”
2. Confirm opening the “setup code”, if not, find on 1.4
3. Scan “change RF information”
4. Successively scan “4”、“6”、“4”、“1”、“4”、“9”、“4”、“C”
5. Scan “save” code

7.7 Output Protocol

The output format of the decoded result can be modified in serial/virtual serial mode by scanning the following Settings code.

The format output with protocol is as follows: <03>< length >< decoded data >.

In addition, when in serial/virtual serial mode the output mode of the band protocol is enabled, the module will not add an terminator to the decoded data.

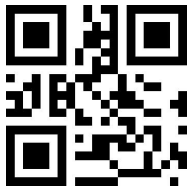

***Pure data**



With the agreement

7.8 UPCA convert to EAN13

Scan the following code to set UPCA convert to EAN13.



Allow



***Forbid**

7.9 Commodity Code Check Output

Scan the following code to set commodity code check digit output (including EAN8 EAN13 / UPCE0 / UPCE1 / UPCA).



***Allow**



Forbid

8 Bar code type enables/disable configuration

8.1 All types of bar code can be decoded

After scan “ Forbid read all bar code” , module will only support to scan setup code.



Support all



Forbid read all bar code



*Open default support types

8.2 Strengthen the Reading Ability

The bar code reading ability is enhanced through configuration, which will improve the reading Angle of all bar codes, improve the equipment's support for angles above 45° , and improve the contrast and gradient code support. Disabling Angle hardening will increase decoding speed.



*Forbid to enhanced



Enhanced

8.3 EAN13



Allow reading EAN13



Forbid reading EAN13



* 2 bits extra-code Forbidden

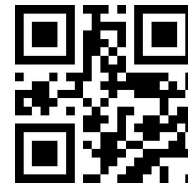

2 bits extra-code Allow



*5 bits extra-code Forbidden



5 bits extra-code Allow

8.4 EAN8



*Allow reading EAN8



Forbid reading EAN8



* 2 bits extra-code Forbidden



2 bits extra-code Allow



*5 bits extra-code Forbidden



5 bits extra-code Allow

8.5 UPCA



*Allow reading UPCA



Forbid reading UPCA



* 2 bits extra-code Forbidden



2 bits extra-code Allow



*5 bits extra-code Forbidden



5 bits extra-code Allow

8.6 UPCE0



*Allow reading UPCE0



Forbid reading UPCE0

8.7 UPCE1



*Allow reading UPCE1



Forbid reading UPCE1

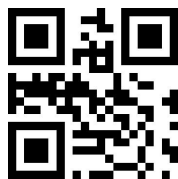

* 2 bits extra-code Forbidden



2 bits extra-code Allow



*5 bits extra-code Forbidden



5 bits extra-code Allow

8.8 Code128



***Allow reading Code128**

Scan following code to change min length of code 128



Code128 min length at 0

Scan following code to change max length of code 128



***Code128 max length at 32**



Forbid reading Code128



***Code128min length at 4**



Code128 max length at 255

8.9 Code39



***Allow reading Code39**

Scan following code to change min length of code39



Code39 min length at 0

Scan following code to change start character and tail output of code 39



***Start character No Output**



Forbid reading Code39



***Code39 min length at 4**



Start character Output



***Tail No Output**



Tail Output

Scan following code to change max length of code39



***Code39 max length at 32**



Code39 max length at 255

Scan following code to configure whether Code39 supports Code32 mode and FullAsc mode



***Forbid Code32**



Allow Code32



***Forbid FullAsc Mode**

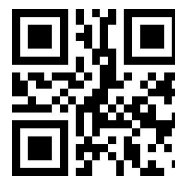

Allow FullAsc Mode

8.10 Code93



Allow reading Code93



Forbid reading Code93

Scan following code to change min length of code93



Code93 min length at 0

Scan following code to change max length of code93



***Code93max length at 32**

***Code93 min length at 4**



Code93max length at 255

8.11 CodeBar



***Allow reading CodeBar**



Forbid reading CodeBar

Scan following code to allow/forbid to send Start-stop operator



Send CodeBar Start-stop operator



***Not send CodeBar Start-stop operator**

Scan following code to change min length of CodeBar



CodeBar min length at 0



***CodeBar min length at 4**

Scan following code to change max length of CodeBar



***CodeBar max length at 32**



CodeBar max length at 255

8.12 QR



***Allow reading QR**

Forbid reading QR

8.13 Interleaved 2 of 5



Allow reading Interleaved 2 of 5

Scan following code to set min length of Interleaved 2 of 5



Interleaved 2 of 5 min length at 0

Scan following code to set max length of Interleaved 2 of 5



***Interleaved 2 of 5 max length at 32**



Default Forbid reading Interleaved 2 of 5



Default Interleaved 2 of 5 min length at 4



Interleaved 2 of 5 max length at 255

8.14 Industrial 25



Allow reading Industrial 25

Scan following code to set min length of Interleaved 25



Industrial 25 min length at 0

Scan following code to set max length of Interleaved 25



***Forbid reading Industrial 25**



***Industrial 25 min length at 4**



***Industrial 25 max length at 32**



Industrial 25 max length at 255

8.15 Matrix 2 of 5



Allow reading Matrix 2 of 5



***Forbid reading Matrix 2 of 5**

Scan following code to set min length of Matrix 2 of 5



Matrix 2 of 5 min length at 0



***Matrix 2 of 5 min length at 4**

Scan following code to set max length of Matrix 2 of 5



***Matrix 2 of 5 max length at 32**



Matrix 2 of 5 max length at 255

Scan following code to set the validation format of Matrix 2 of 5



Matrix 2 of 5 validation format Mod10



***Matrix 2 of 5 validation format None**

8.16 Code11



Allow reading Code11



***Forbid reading Code11**

Scan following code to set min length of Code11



Code11 min length at 0



***Code11 min length at 4**

Scan following code to set max length of Code11



***Code11 max length at 32**



Code11 max length at 255

Scan following code to set the validation format of Code11



Code11 use 1bit check



***Code11 use 2bit check**

8.17 MSI



Allow reading MSI



***Forbid reading MSI**

Scan following code to set min length of MSI



MSI min length at 0



***MSI min length at 4**

Scan following code to set max length of MSI



***MSI max length at 32**



MSI max length at 255

8.18 RS



Allow reading RSS-14



*Forbid reading RSS-14



Allow reading limited RSS



*Forbid reading limited RSS



Allow reading expended RSS



*Forbid reading expended RSS

Scan following code to set min length of RSS



RSS min length at 0



*RSS min length at 4

Scan following code to set max length of RSS



*RSS max length at 32



RSS max length at 255

8.19 DM



*Allow reading DM



Forbid reading DM

Scan following code to set whether the module supports decoding multiple DM barcodes simultaneously



***Forbid Read multiple DM barcodes simultaneously**



**Allow Read multiple DM barcodes
Simultaneously**

8.20 PDF417



***Allow reading PDF417**



Forbid reading PDF417

9 Serial Port Instruction

Users can settle the module by sending instruction from mainframe.

Please make sure communicate parameter complete matching between module and mainframe.

Module default serial communicate parameter: **Baud rate 9600bps; No check; 8 bit data; 1 bit stop bit; No flow control.**

9.1 CRC Algorithm

CRC: CRC_CCITT check value (2 bytes).

Suitable for Types、Lens、Address、Datas;

Characteristic polynomial : $X^{16}+X^{12}+X^5+1$, multinomial coefficient: 0x1021, original value:0 ;

For single byte, the highest bit will be calculated at first, output will be without negation.

Reference code of C:

```
unsigned int crc_cal_by_bit(unsigned char* ptr, unsigned int len)
{
    unsigned int crc = 0;
    while(len-- != 0)
    {
        for(unsigned char i = 0x80; i != 0; i /= 2)
        {
            crc *= 2;
            if((crc&0x10000) != 0)
                crc ^= 0x11021;
            if((*ptr&i) != 0)
                crc ^= 0x1021;
        }
        ptr++;
    }
    return crc;
}
```

PS: when no need for checking CRC, CRC bite can be filled in 0xAB 0xCD

9.2 Read Zone Bit

Max 256 bytes/time for zone bit reading.

Command Format:

Input: {Head1} {Types} {Lens} {Address} {Datas} {CRC}

PS: Head1: 0x7E 0x00 (2 bytes)

Types: 0x07 (1 byte)

Lens: 0x01 (1 byte)

Address : 0x0000~0x00FF (2 bytes) , address to start reading zone bit

Datas: 0x00~0xFF (1 byte) , Numbers of zone bit for Sequential read, 0x00= 256byets

CRC: CRC_CCITT check value (2 bytes). Suitable for Types、Lens、Address、Datas;

Characteristic polynomial : $X^{16}+X^{12}+X^5+1$, multinomial coefficient: 0x1021, original value:0 ;

For single byte, the highest bit will be calculated at first, output will be without negation.

The reference code of C is as follows:

```

unsigned int crc_cal_by_bit(unsigned char* ptr, unsigned int len)
{
    unsigned int crc = 0;
    while(len-- != 0)
    {
        for(unsigned char i = 0x80; i != 0; i /= 2)
        {
            crc *= 2;
            if((crc&0x10000) != 0) //Last CRC * 2 , if the first one is 1, so divide 0x11021
                crc ^= 0x11021;
            if(*ptr&i != 0) //If the standard is 1, so CRC = last CRC + standard CRC_CCITT
                crc ^= 0x1021;
        }
        ptr++;
    }
    return crc;
}

```

Note: users can fill 0xAB 0xCD at CRC byte when CRC validation is not required.

Output: {Head2} {Types} {Lens} {Datas} {CRC}

1) Read successfully and return data

PS: Head2: 0x02 0x00

Types: 0x00 (read succeed)

Lens: numbers of upload bytes

Datas: 0x00~0xFF means read data.

CRC: CRC_CCITT check value. Suitable for Types、Lens、 Datas;

Characteristic polynomial : $X^{16}+X^{12}+X^5+1$, multinomial coefficient: 0x1021, original value:0 ;

For single byte, the highest bit will be calculated at first, output will be without negation.

(The reference code is the same as above)

2) CRC failed

No response command

3) Unknown command response

No response command

E.G.:

Read address 0x000A of Zone bit

1) Read successfully and return data is 0x3E.

Input: 0x7E 0x00 0x07 0x01 0x00 0x0A 0x01 0xEE 0x8A

Output: 0x02 0x00 0x00 0x01 0x3E 0xE4 0xAC

2) CRC wrong

Input: 0x7E 0x00 0x07 0x01 0x00 0x0A 0x01 0x11 0x22

Output : None

3) When length of command to short or more than 400ms after 0x7e 0x00, treat as unknown command.

Input: 0x7E 0x00 0x07 0x01 0x00 0x0A 0x01

Output: None

9.3 Write Zone Bit

Max 256 bytes/time for zone bit reading.

The modified content of the zone bit will be lost after power failure. If the modified content is needed after power loss,You need to save the zone bit to internal Flash(9.4).

Command Format:

Input: {Head1} {Types} {Lens} {Address} {Datas} {CRC}

PS: Head1: 0x7E 0x00 (2 bytes)

Types: 0x08 (1 byte)

Lens: 0x00~0xFF (1 byte) , means numbers of bytes of this datas, times of continuous writing.

Address: 0x0000~0xFFFF (2 bytes) , start location of write

Datas: 0x00~0xFF (1~255 bytes) , dates wrote in zone bit. When configuring multiple zone bit,must follow the order of address from low to high to fill the data domains.

CRC: CRC_CCITT check value (2 bytes). Suitable for Types、Lens、Address、Datas;
 Characteristic polynomial : $X^{16}+X^{12}+X^5+1$, multinomial coefficient: 0x1021, original value:0 ;
 For single byte, the highest bit will be calculated at first, output will be without negation.

The reference code of C is as follows:

```

unsigned int crc_cal_by_bit(unsigned char* ptr, unsigned int len)
{
    unsigned int crc = 0;
    while(len-- != 0)
    {
        for(unsigned char i = 0x80; i != 0; i /= 2)
        {
            crc *= 2;
            if((crc&0x10000) != 0) //Last CRC * 2 , if the first one is 1, so divide 0x11021
                crc ^= 0x11021;
            if((*ptr&i) != 0) //If the standard is 1, so CRC = last CRC + standard CRC_CCITT
                crc ^= 0x1021;
        }
        ptr++;
    }
    return crc;
}
    
```

Note: users can fill 0xAB 0xCD at CRC byte when CRC validation is not required.

Output: {Head2} {Types} {Lens} {Datas} {CRC}

1) Read successfully

PS: Head2: 0x02 0x00

Types: 0x00 (read succeed)

Lens: 0x01

Datas: 0x00

CRC: CRC_CCITT check value (0x33 0x31)

2) CRC failed

No response command

3) Unknown command response

No response command

E.G.:

Write 0x3E in 0x000A of zone bit

1) Successfully set

Input : 0x7E 0x00 0x08 0x01 0x00 0x0A 0x3E 0x4C 0xCF

Output: 0x02 0x00 0x00 0x01 0x00 0x33 0x31

2) CRC wrong

Input: 0x7E 0x00 0x08 0x01 0x00 0x0A 0x3E 0x11 0x22

Output: None

3) When length of command is too short or more than 400ms after 0x7e 0x00, treat as unknown command.

Input: 0x7E 0x00 0x08 0x01 0x00 0x0A 0x3E

Output: None

9.4 Save Zone Bit To Internal Flash Instruction

To save the device of the zone bit list to internal Flash, you need to send a save command.

Note: the device cannot save a single zone bit configuration separately, and must keep the entire list at the same time.

Command Format:

Input: {Head1} {Types} {Lens} {Address} {Datas} {CRC}

PS: Head1: 0x7E 0x00

Types: 0x09

Lens: 0x01

Address: 0x0000

Datas: 0x00

CRC: CRC_CCITT check value (0xDE 0xC8)

Output: {Head2} {Types} {Lens} {Datas} {CRC}

1) Saved successful

PS: Head2: 0x02 0x00

Types: 0x00 (read succeed)

Lens: 0x01

Datas: 0x00

CRC: CRC_CCITT check value (0x33 0x31)

2) CRC failed

No response command

3) Unknown command response

No response command

9.5 Zone Bit Reset To Defaults

Command Format:

Input: {Head1} {Types} {Lens} {Address} {Datas} {CRC}

PS: Head1: 0x7E 0x00

Types: 0x09

Lens: 0x01

Address: 0x0000

Datas: 0xFF

CRC: CRC_CCITT check value

Output: {Head2} {Types} {Lens} {Datas} {CRC}

1) Saved successful

PS: Head2: 0x02 0x00

Types: 0x00 (read succeed)

Lens: 0x01

Datas: 0x00

CRC: CRC_CCITT check value (0x33 0x31)

2) CRC failed

No response command

3) Unknown command response

No response command

9.6 Program Erasure Operation

Command Format:

Input: {Head1} {Types} {Lens} { NotUse } {Datas} {CRC}

PS: Head1: 0x7E 0x00 (2 bytes)

Types: 0x05 (1 byte)

Lens: 0x01 (1 byte) Numbers of Datas for Sequential read

NotUse: 0x0000 (2 bytes) , 2 bytes 0x00

Datas: 0x11/0x22/0x33 (1 bytes) , represents the data to be written;0x11:Erase the bootstrap;
0x22:erase the user program;0x33:Erase the bootstrap and user program.

CRC: CRC_CCITT check value (2 bytes). Suitable for Types、Lens、NotUse、Datas;
Characteristic polynomial : $X^{16}+X^{12}+X^5+1$, multinomial coefficient: 0x1021, original value:0 ;
For single byte, the highest bit will be calculated at first, output will be without negation.

The reference code of C is as follows:

```

unsigned int crc_cal_by_bit(unsigned char* ptr, unsigned int len)
{
    unsigned int crc = 0;
    while(len-- != 0)
    {
        for(unsigned char i = 0x80; i != 0; i /= 2)
        {
            crc *= 2;
            if((crc&0x10000) != 0) //Last CRC * 2 , if the first one is 1, so divide 0x11021
                crc ^= 0x11021;
            if(*ptr&i != 0) //If the standard is 1, so CRC = last CRC + standard CRC_CCITT
                crc ^= 0x1021;
        }
        ptr++;
    }
    return crc;
}

```

Note: users can fill 0xAB 0xCD at CRC byte when CRC validation is not required.

Output: {Head2} {Types} {Lens} {Datas} {CRC}

1) Erased successful

PS: Head2: 0x02 0x00

Types: 0x00 (read succeed)

Lens: 0x01

Datas: 0x00

CRC: CRC_CCITT check value (0x33 0x31)

2) CRC failed

No response command

3) Unknown command response

No response command

E.G.:

After erasure the user program, the device will automatically enter the boot program and wait for the download of the new user program

4) Erased successful

Input : 0x7E 0x00 0x05 0x01 0x00 0x00 0x22 xx xx

Output: 0x02 0x00 0x00 0x01 0x00 0x33 0x31

5) CRC wrong

Input: 0x7E 0x00 0x05 0x01 0x00 0x00 0x22 xx xx

Output: None

6) When length of command to short or more than 400ms after 0x7e 0x00, treat as unknown command.

Input: 0x7E 0x00 0x05 0x01 0x00 0x00 0x22

Output: None

9.7 List of zone bit

Zone Bit	0x0000
Data Bit	Function
Bit 7	1: Open LED when successfully read 0: Close
Bit 6	1: Mute off 0: Mute on
Bit 5-4	00: No light 01: Standard 10/11: Always on
Bit 3-2	00: No light 01: Standard 10/11: Always on
Bit 1-0	00: Manual Mode 01: Command Triggered Mode 10: Continuous mode 11: Induction Mode
Zone Bit	0x0002
Data Bit	Function
Bit 7-1	Keep
Bit 0	Command mode triggers flags, Automatically reset after scanning 1: trigger 0: no trigger
Zone Bit	0x0003
Data Bit	Function
Bit 7-2	HID query cycle. Cycle = (Reg0x0003[7:2]+1) ms
Bit 1	1: Close Settlement Code 0: Open
Bit0	1: Output content of settlement code 0: Not output
Zone Bit	0x0004
Data Bit	Function
Bit 7-0	The time of Image stabilization 0x00-0xFF: 0.0-25.5s

Zone Bit	0x0005
Data Bit	Function
Bit 7-0	Read interval 0x00: No interval 0x01-0xFF: 0.0-25.5s
Zone Bit	0x0006
Data Bit	Function
Bit 7-0	Time for single read 0x01-0xFF: 0.0-25.5s
Zone Bit	0x0007
Data Bit	Function
Bit 7	Automatic deep sleep 1: On 0: Off
Bit6-0	Free Time (High Bit14-8) Unit: 100ms
Zone Bit	0x0008
Data Bit	Function
Bit7-0	Free Time (Low Bit14-8) Unit: 100ms
Zone Bit	0x0009
Data Bit	Function
Bit7-2	HID the interval before release Interval = (Reg0x0009[7:2]) ms
Bit 1-0	Image rollovers 00: Forbid 01: Allow 10/11: Keep
Zone Bit	0x000B
Data Bit	Function
Bit 7-0	Time duration for successfully read sound 0x00-0xFF; 0-255ms
Zone Bit	0x000C
Data Bit	Function
Bit 7-2	HID the interval after release Interval = (Reg0x000C[7:2]) ms
Bit1	CapsLock Switch 0: On 1: Off
Bit0	Piezo Buzzer 0: high level when free, low level when busy 1: low level when free, high level when busy
Zone Bit	0x000D
Data Bit	Function
Bit 6	Virtual keyboard enable flags 0: Forbid 1: Allow
Bit5-4	Input data encoding format 00: GBK 01: Keep 10: AUTO 11: UTF8
Bit 3-2	Output data encoding format 00: GBK 01: UNICODE 10: Keep 11: UTF8
Bit1-0	00: serial port output 01: USB PC Keyboard 10: Keep 11: USB virtual serial port

Zone Bit	0x000E
Data Bit	Function
Bit 7-4	Light sleep free time Free time= (Reg0x000E[7:4]*500) ms
Bit3	Keep
Bit2	1: Decode successfully sound on 0: Decode successfully sound off
Bit1	1: Turn off start-up tone 0: Turn on start-up tone
Bit0	1: Allow serial port mode HID protocol 0: Forbid
Zone Bit	0x000F
Data Bit	Function
Bit7-0	Sensitivity adjustment parameter 1 0x00-0xFF: higher value, lower sensitivity, default value 0x32
Zone Bit	0x0010
Data Bit	Function
Bit7-0	Sensitivity adjustment parameter 2 0x00-0xFF: higher value, lower sensitivity, default value 0x0A
Zone Bit	0x0011
Data Bit	Function
Bit 7-0	Exposure Settings - high bytes 0x00-0xFF
Zone Bit	0x0012
Data Bit	Function
Bit 7-0	Exposure Settings - low bytes 0x00-0xFF
Zone Bit	0x0013
Data Bit	Function
Bit 7	Same barcode reading delay setting 0: Turn off 1: Turn on
Bit 6-0	Same barcode reading delay time (Unit: 100ms) 0x00: Infinite length 0x01-0x7F: 0.1-12.7s;
Zone Bit	0x0014
Data Bit	Function
Bit 7-0	Reserved time for information output (Unit: 10ms) 0x00-0xFF: 0-2.55 s
Zone Bit	0x002B, 0x002A
Data Bit	Function
Bit 15	Keep
Bit 14-13	Parity Mode: 0: None 1: Odd 2: Even
Bit 12-0	0x09C4: Series rate 1200 bps 0x0271: Series rate 4800 bps 0x0139: Series rate 9600 bps 0x00D0: Series rate 14400 bps 0x009C: Series rate 19200 bps

	0: Forbid 1: Allow
Zone Bit	0x0033
Data Bit	Function
Bit 7-1	Keep
Bit0	Read Code128 0: Forbid 1: Allow
Zone Bit	0x0034
Data Bit	Function
Bit 7-0	Code128 Information minimum length setting 0x00-0xFF: 0-255Byte
Zone Bit	0x0035
Data Bit	Function
Bit 7-0	Code128 Information maximum length setting 0x00-0xFF: 0-255Byte
Zone Bit	0x0036
Data Bit	Function
Bit 7-1	Keep
Bit0	Read Code39 0: Forbid 1: Allow
Zone Bit	0x0037
Data Bit	Function
Bit 7-0	Code39 Information minimum length setting 0x00-0xFF: 0-255Byte
Zone Bit	0x0038
Data Bit	Function
Bit 7-0	Code39 Information maximum length setting 0x00-0xFF: 0-255Byte
Zone Bit	0x0039
Data Bit	Function
Bit 7-1	Keep
Bit0	Read Code93 0: Forbid 1: Allow
Zone Bit	0x003A
Data Bit	Function
Bit 7-0	Code93 Information minimum length setting 0x00-0xFF: 0-255Byte
Zone Bit	0x003B
Data Bit	Function
Bit 7-0	Code93 Information maximum length setting 0x00-0xFF: 0-255Byte
Zone Bit	0x003C
Data Bit	Function

Bit 7-2	Keep
Bit1	CodeBar code send the start/end character 0: Forbid 1: Allow
Bit0	Read CodeBar 0: Forbid 1: Allow
Zone Bit	0x003D
Data Bit	Function
Bit 7-0	CodeBar Information minimum length setting 0x00-0xFF: 0-255Byte
Zone Bit	0x003E
Data Bit	Function
Bit 7-0	CodeBar Information maximum length setting 0x00-0xFF: 0-255Byte
Zone Bit	0x003F
Data Bit	Function
Bit 7-1	Keep
Bit0	Read QR 0: forbid 1: allow
Zone Bit	0x0040
Data Bit	Function
Bit 7-1	Keep
Bit0	Read Interleaved 2 of 5 0: forbid 1: allow
Zone Bit	0x0041
Data Bit	Function
Bit 7-0	Interleaved 2 of 5 Information minimum length setting 0x00-0xFF: 0-255Byte
Zone Bit	0x0042
Data Bit	Function
Bit 7-0	Interleaved 2 of 5 Information maximum length setting 0x00-0xFF: 0-255Byte
Zone Bit	0x0043
Data Bit	Function
Bit 7-1	Keep
Bit0	Read Industrial 25 0: forbid 1: allow
Zone Bit	0x0044
Data Bit	Function
Bit 7-0	Industrial 25 Information minimum length setting 0x00-0xFF: 0-255Byte
Zone Bit	0x0045
Data Bit	Function

Bit 7-0	Industrial 25 Information maximum length setting 0x00-0xFF: 0-255Byte
Zone Bit	0x0046
Data Bit	Function
Bit 7-1	Keep
Bit0	Read Matrix 2 of 5 0: forbid 1: allow
Zone Bit	0x0047
Data Bit	Function
Bit 7-0	Matrix 2 of 5 Information minimum length setting 0x00-0xFF: 0-255Byte
Zone Bit	0x0048
Data Bit	Function
Bit 7-0	Matrix 2 of 5 Information maximum length setting 0x00-0xFF: 0-255Byte
Zone Bit	0x0049
Data Bit	Function
Bit 7-1	Keep
Bit0	Read Code11 0: forbid 1: allow
Zone Bit	0x004A
Data Bit	Function
Bit 7-0	Code11 Information minimum length setting 0x00-0xFF: 0-255Byte
Zone Bit	0x004B
Data Bit	Function
Bit 7-0	Code11 Information maximum length setting 0x00-0xFF: 0-255Byte
Zone Bit	0x004C
Data Bit	Function
Bit 7-1	Keep
Bit0	Read MSI 0: forbid 1: allow
Zone Bit	0x004D
Data Bit	Function
Bit 7-0	MSI Information minimum length setting 0x00-0xFF: 0-255Byte
Zone Bit	0x004E
Data Bit	Function
Bit 7-0	MSI Information maximum length setting 0x00-0xFF: 0-255Byte
Zone Bit	0x004F

Data Bit	Function
Bit 7-1	Keep
Bit0	Read RSS-14 0: forbid 1: allow
Zone Bit	0x0050
Data Bit	Function
Bit 7-1	Keep
Bit0	Read limited RSS 0: forbid 1: allow
Zone Bit	0x0051
Data Bit	Function
Bit 7-1	Keep
Bit0	Read Expended RSS 0: forbid 1: allow
Zone Bit	0x0052
Data Bit	Function
Bit 7-0	RSS Information minimum length setting 0x00-0xFF: 0-255Byte
Zone Bit	0x0053
Data Bit	Function
Bit 7-0	RSS Information maximum length setting 0x00-0xFF: 0-255Byte
Zone Bit	0x0054
Data Bit	Function
Bit 7-1	Keep
Bit0	Read DM 0: forbid 1: allow
Zone Bit	0x0055
Data Bit	Function
Bit 7-1	Keep
Bit0	Read PDF17 0: forbid 1: allow
Zone Bit	0x0060
Data Bit	Function
Bit 7	Serial/virtual serial output with or without protocol 0: Original data 1: With protocol
Bit6-5	Type of Tailed 00: CR(0x0D) 01: CRLF(0x0D,0x0A) 10: TAB(0x09) 11: None
Bit4	1: Allow add RF 0: forbid
Bit3	1: Allow add prefix 0: forbid
Bit2	1: Allow add Code ID 0: forbid

Bit1	1: Allow add suffix 0: forbid
Bit0	1: Allow add tail 0: forbid
Zone Bit	0x0061
Data Bit	Function
Bit 7-0	Keyboard Settlement 00: US 01: Czech 02: France 03: Germany 04: Hungary 05: Italy 06: Japan 07: Spain 08: Turkey Q 09: Turkey F
Zone Bit	0x0062
Data Bit	Function
Bit 7-4	Length of prefix 0x00-0x0F
Bit3-0	Length of suffix 0x00-0x0F
标志位	0x0063 – 0x0071
Data Bit	Function
Bit 7-0	Prefix 0x00-0xFF: Content, max 15Byte
标志位	0x0072 - 0x0080
Data Bit	Function
Bit 7-0	Suffix 0x00-0xFF: Content, max 15Byte
Zone Bit	0x0081
Data Bit	Function
Bit 7-4	Keep
Bit3-0	RF length 0x00-0x0F
Zone Bit	0x0082– 0x0090
Data Bit	Function
Bit 7-0	RF content 0x00-0xFF: Content, max 15Byte
Zone Bit	0x0091 – 0x00A4
Data Bit	Function
Bit 7-0	Code ID settlement 0x41-0x5a & 0x61-0x7a (A-Z,a-z) : Code ID as appendix C
Zone Bit	0x00B0
Data Bit	Function
Bit 7-2	Keep
Bit 1-0	Data Cut out settlement 00: Output whole data 01: Output Start part 10: Output End part 11: Output center part
Zone Bit	0x00B1
Data Bit	Function

Bit 7-0	Cut out M bytes from start 0x00-0xFF: 0-255 Byte
Zone Bit	0x00B2
Data Bit	Function
Bit 7-0	Cut out N bytes from end 0x00-0xFF: 0-255 Byte
Zone Bit	0x00D9 (Only read Zone bit)
Data Bit	Function
Bit 7-0	Function Zone bit 0x55: reset to defaults 0xA0: Mild sleep, wake up by UART interrupt; Power consumption:18mA 0xA5: Deep sleep,wake up by UART interrupt; module reboot; Power consumption:1.8mA 0x00: write 0 to wake up module
Zone Bit	0x00E1 (Only read Zone bit)
Data Bit	Function
Bit 7-0	Hardware Version 0x64: V1.00 0x6E: V1.10 0x78: V1.20 0x82: V1.30 0x8C: V1.40
Zone Bit	0x00E2 (Only read Zone bit)
Data Bit	Function
Bit 7-0	Software Version 0x64: V1.00 0x6E: V1.10 0x78: V1.20 0x82: V1.30 0x8C: V1.40
Zone Bit	0x00E3 (Only read Zone bit)
Data Bit	Function
Bit 7-0	Year of software (Add 2000) 0x0F: 2015 0x10: 2016 0x11: 2017
Zone Bit	0x00E4 (Only read Zone bit)
Data Bit	Function
Bit 7-0	Software month 0x09: 9 0x0A: 10

	0x0B: 11
Zone Bit	0x00E5 (Only read Zone bit)
Data Bit	Function
Bit 7-0	Software date 0x09: 9 0x0A: 10 0x0B: 11

10 Appendix A: Common serial port instruction

Parameter		Default Setting	Note
Communication interface			
TTL-232	Baud rate	9600	
	Verification	No	
	Bata Bit	8 bit	
	Stop Bit	1 bit	
	CTSRTS	No	

11 Appendix B: Common serial port instruction

Function	Instruction
Baud rate to 9600	7E 00 08 02 00 2A 39 01 A7 EA
Save settlements to Internal Flash	7E 00 09 01 00 00 00 DE C8
Find baud rate	7E 00 07 01 00 2A 02 D8 0F

Module will return following info after mainframe send serial port instruction - find baud rate

Return information	Baud rate
02 00 00 02 C4 09 SS SS	1200
02 00 00 02 71 02 SS SS	4800
02 00 00 02 39 01 SS SS	9600
02 00 00 02 D0 00 SS SS	14400
02 00 00 02 9C 00 SS SS	19200
02 00 00 02 4E 00 SS SS	38400
02 00 00 02 34 00 SS SS	57600

PS: SS SS= check value

12 Appendix C: Code ID List

Type of Bar Code	Corresponding character	Zone bit address
EAN-13	d	0x91
EAN-8	d	0x92
UPC-A	c	0x93
UPC-E0	c	0x94
UPC-E1	c	0x95
Code 128	j	0x96
Code 39	b	0x97
Code 93	i	0x98
Codabar	a	0x99
Interleaved 2 of 5	e	0x9A
Industrial 2 of 5	D	0x9B
Matrix 2 of 5	v	0x9C
Code 11	H	0x9D
MSI-Plessey	m	0x9E
GS1 Databar(RSS-14)	R	0x9F
GS1 Databar Limited(RSS)	R	0xA0
GS1 Databar Expanded(RSS)	R	0xA1
QR Code	Q	0xA2
Data Matrix	u	0xA3
PDF 417	r	0xA4

13 Appendix D: ASCII

Hexadecimal	Decimalism	Character
00	0	NUL
01	1	SOH
02	2	STX
03	3	ETX
04	4	EOT
05	5	ENQ
06	6	ACK
07	7	BEL
08	8	BS
09	9	HT
0a	10	LF
0b	11	VT
0c	12	FF
0d	13	CR
0e	14	SO
0f	15	SI
10	16	DLE
11	17	DC1
12	18	DC2
13	19	DC3
14	20	DC4
15	21	NAK
16	22	SYN
17	23	ETB
18	24	CAN
19	25	EM
1a	26	SUB
1b	27	ESC
1c	28	FS

Hexadecimal	Decimalism	Character
1d	29	GS
1e	30	RS
1f	31	US
20	32	SP
21	33	!
22	34	"
23	35	#
24	36	\$
25	37	%
26	38	&
27	39	`
28	40	(
29	41)
2a	42	*
2b	43	+
2c	44	,
2d	45	-
2e	46	.
2f	47	/
30	48	0
31	49	1
32	50	2
33	51	3
34	52	4
35	53	5
36	54	6
37	55	7
38	56	8
39	57	9
3a	58	:
3b	59	;
3c	60	<

3d	61	=
3e	62	>
Hexadecimal	Decimalism	Character
3f	63	?
40	64	@
41	65	A
42	66	B
43	67	C
44	68	D
45	69	E
46	70	F
47	71	G
48	72	H
49	73	I
4a	74	J
4b	75	K
4c	76	L
4d	77	M
4e	78	N
4f	79	O
50	80	P
51	81	Q
52	82	R
53	83	S
54	84	T
55	85	U
56	86	V
57	87	W
58	88	X
59	89	Y
5a	90	Z
5b	91	[
5c	92	\
5d	93]
5e	94	^

5f	95	–
60	96	'
Hexadecimal	Decimalism	Character
61	97	a
62	98	b
63	99	c
64	100	d
65	101	e
66	102	f
67	103	g
68	104	h
69	105	i
6a	106	j
6b	107	k
6c	108	l
6d	109	m
6e	110	n
6f	111	o
70	112	p
71	113	q
72	114	r
73	115	s
74	116	t
75	117	u
76	118	v
77	119	w
78	120	x
79	121	y
7a	122	z
7b	123	{
7c	124	
7d	125	}
7e	126	~
7f	127	DEL

14 Appendix E: Data code

0 ~ 9



0



1



2



3



4



5



6



7

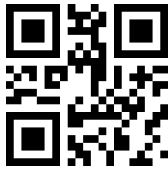

8



9

A - F



A



B



C



D



E



F

15 Appendix F: Save or Cancel

After reading the data code, you need to scan the "save" setting code to save the data which you read. If there is an error when reading the data code, you can cancel the error reading.

For example, read a set code, and read data "A", "B", "C" and "D" in turn.

If you read "cancel the last read bit", the last read digit "D" will be cancelled.

If you read "cancel the previous read a string of data" will cancel the read data "ABCD",

If you read "cancel modification Settings", you will cancel the data "ABCD" and exit the modification Settings.



Save



Cancel the last read bit



Cancel the previous read a string of data



Cancel modification settings