

Data Sheet AM1011A

Humidity and Temperature Module

- Fully calibrated
- Analog voltage output
- Excellent long-term stability
- Low power consumption, small size, high performance

Product Summary

AM1011A analog temperature and humidity module is a have already calibrated analog signal output of the temperature and humidity sensor, the sensor signals using analog voltage loss, out of the way; This module has high precision, high reliability, good consistency, and with temperature compensation, ensure the long-term stability is good, easy to use and high performance, especially suitable for the quality, cost, more demanding enterprise to use.

1 Product Description

It can be widely used in consumer electronics, medical, automotive, industrial, meteorological and other fields, such as: HVAC, dehumidifiers and refrigerators and other home appliances, testing and testing equipment and other related temperature and humidity detection and control products.

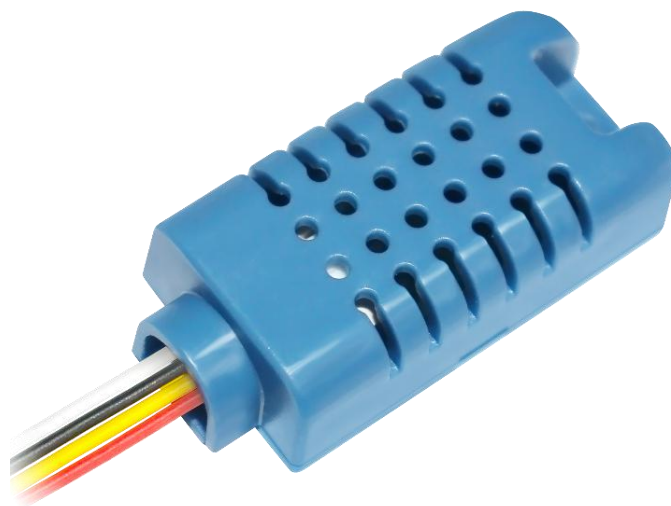

Figure 1. AM1011A

2 Sensor Specifications

Relative Humidity

Parameter	Condition	Min	Typical Value	Max	Units
Resolution	-	-	0.5	-	%RH
Scope of Work	extended ¹	0	-	100	%RH
Accuracy Tolerance ²	-	-	±3	Figure2	%RH
Repeatability	-	-	±0.1	-	%RH
Interchangeability	-	Complete interchangeable			
Response time ³	τ (63%)	-	<8	-	s
Hysteresis	-	-	±1	-	%RH
Prolonged Drift ⁴	Typical value	-	<1	-	%RH

Table 1. Humidity Sensor Performance

Temperature

The temperature sensor is the NTC thermistor temperature10k, sensor parameters as shown in Table 2.

Models	Resistance (R25)	B (K)	Dissipative Coefficient (mW/°C)	Thermal Time Constant (s)	Rated Power (mW)	Working Temperature Range (°C)
CN0603R103B3435FT	10kΩ	3435	≥ 2.5	≤ 18	150	-40~80

Table 2. Temperature Performance Specification

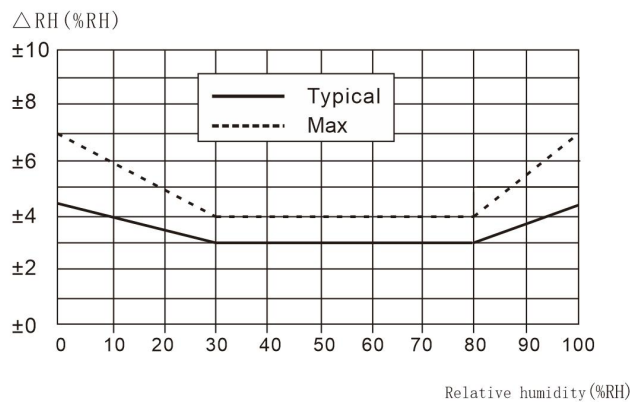

Figure 2. Relative Humidity Accuracy Specification

Electrical specification

Parameter	Condition	Min	Typical	Max	Unit
Supply voltage	-	4.75	5.0	5.5	V
Output voltage	-	0	-	3	V
Power dissipation ⁵	Measure	-	1.5	-	MA
Humidity of the sampling period	-	2	2.5	-	S
Measuring temperature range	NTC 10K	-40	-	80	°C
Temperature output	NTC 10K	Refer to the attached resistance Table			

Table 3. Electrical characteristics

1 Normal working range: 0-80% RH, beyond this range sensor readings will have deviation (after 60 hours, at 90% RH humidity drift >3% RH). The scope of work further limit in -40-80 °C.

2 This precision for factory inspection, sensors in 25 °C under the condition of the power supply voltage of 5 v test precision. This value does not include the hysteresis and nonlinear and applies only to the non-cooling conditions.

3 Under the condition of 25 °C and 1m/s airflow, the time required to reach63% of the first order response.

4 If there are volatile solvents, tape with pungent odor, adhesive around the sensor and packaging materials, the readings may shift. Please refer to relevant documents for detailed instructions.

5 The minimum and maximum power consumption are based on the condition that VDD=5V and T<60°C.The mean is the value measured every two seconds.

3 AM1011A User Guide

3.1 Operating conditions

The sensor has Table performance within the recommended operating range, as shown in Figure 3. Prolonged exposure to conditions outside the normal range, especially at humidity > 80%, may cause temporary signal drift (drift +3% RH after 60 hours). When restored to normal operating conditions, the sensor will slowly self-restore to the correction state. See section 4.2, "Recovery processing," to speed up the recovery process. Long-term use under abnormal conditions will accelerate the aging of the product.

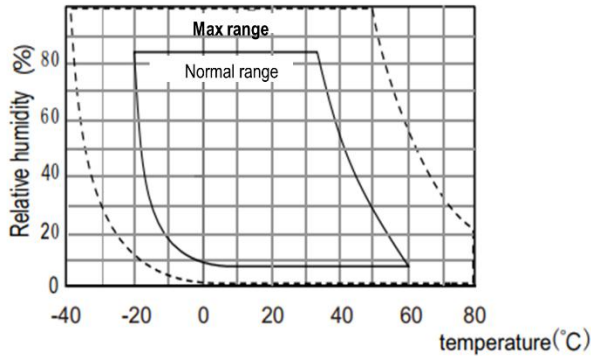

Figure 3. Working conditions.

3.2 RH accuracy at different temperatures

The RH accuracy at 25°C is defined in Figure2. and the typical humidity error in other temperatures segments are shown in Figure4. (Note: the above errors are typical for reference instrument tests with high precision dew point meters (not including hysteresis))

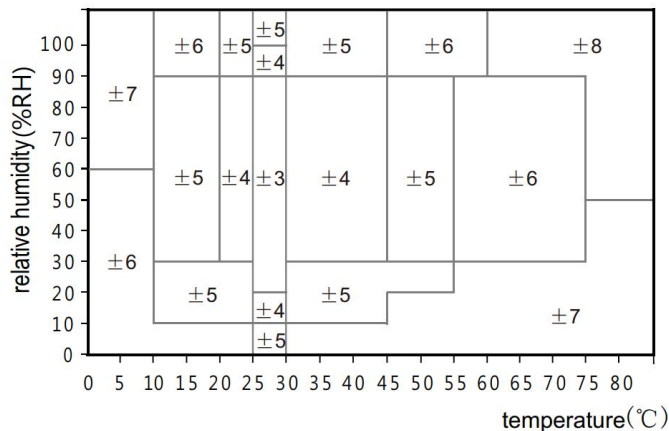

Figure 4. The typical error of humidity in the range of 0~80°C, Unit: (%RH)

4 Applications

4.1 Storage conditions and operating instructions

Humidity Sensitivity Level (MSL) is 1, according to 1PC/JEDEC. J-STD-020 standard. Therefore, it is recommended to be used within one year after shipment. Temperature and humidity sensors are not ordinary electronic components and require careful protection, which the user must pay attention to. Prolonged exposure to high concentrations of chemical vapors will cause the sensor's readings to drift. It is therefore recommended that the sensor be stored in its original packaging, including a sealed ESD pocket, and under the following conditions: Temperature range 10-50°C (0-85°C for a limited time); Humidity 20-60%RH (for sensors without ESD package). For those sensors that have been Removed from their original packaging, we recommend that they be stored in an antistatic bag made of metal PET/AL/CPE. During production and transport, the sensor should be protected from high concentrations of chemical solvents and prolonged exposure to the elements. Avoid contact with volatile glues, tapes, stickers or volatile packaging materials such as blister packs, foams, etc. The production area should be well ventilated.

4.2 Recovery processing

As mentioned above, readings can drift if the sensor is exposed to extreme operating conditions or chemical

vapors. It can be brought back to calibration by the following treatments.

Drying: 6 hours at 60-65°C and <5% RH humidity.

Re-hydration: 6 hours at 20-30°C and >75% RH.⁶

4.3 Temperature effect

The relative humidity of gas is very much dependent on temperature. When measuring humidity, therefore, it should be work at the same temperature as far as possible, that all sensors measuring the same humidity are operating at the same temperature. When doing the test, ensure that the sensor under test and the reference sensor are at the same temperature and then compare the humidity readings.

In addition, when the measuring frequency is too high, sensor's temperature rises and affect measurement accuracy. If you want to ensure That its own temperature rise of less than 0.1°C the activation of AM1011A time should not exceed 10% of the measurement of time——Measurements are recommended every 2 seconds.

4.4 Product application scenario design

A lot of material absorbs moisture and will act as a buffer role, this will increase the response time and delays. So material surrounding the sensor should be careful to choose. Recommend the materials used are: Metal-material, LCP, POM (Polyformaldehyde), PTFEK(Teflon), PE, PEEK, PP, PB, PPS, PSU, PVDF, PVF.

Used in sealing and bonding material (conservative recommendation): it is recommended to use method of epoxy resin for electronic components encapsulation, or silicone. These materials release gas may also be contaminated AM1011A (As shown in 2.1). Sensor assembly, therefore, should be the last, and put it in ventilated place, or Dry at more than 50 °C for 24 hours, in order to release the polluting gas before encapsulation.

5 Interface definition

Pins	Name	Color	Description
1	VDD	Red	Power supply(4.75V to 5.5V)
2	Hout	Yellow	Humidity output(0 to 3v)
3	GND	Black	Ground
4	Tout	White	Temperature for NTC10K

Table 4. Interface definition description

5.1 The power supply pins (VDD, GND)

AM1011A power supply in the range of 4.75 to 5.5 V.

5.2 Voltage output signal (Hout)

Humidity signal from the signal in the form of voltage output, the output voltage range of 0 to 3 V, specific humidity and voltage relationship please reference voltage and humidity characteristics Table (Table 5).

5.3 temperature output signal (Tout)

The temperature sensor is 10k NTC B. 3435 thermistor rather than the analog signal output, users are subject to read circuit, temperature measurement range is -40 - 80°C.

⁶ 75% RH can be readily generated from saturated NaCl

5.4 Temperature sensor wiring diagram

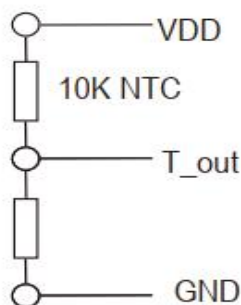

Pull down resistor NTC default connection pull, users need to connect their own pull resistor to achieve temperature and voltage output, resistance value according to the actual situation of self-defined

Figure 5. Schematic diagram of temperature connection mode

6 Electrical characteristics

Electrical characteristics, such as energy consumption, the input, output voltage, etc. all depend on the power supply. Table 3 details the electrical characteristics of the sensor, if not specified, represents the power supply voltage of 5 V. With sensor to get the best effect, please strictly comply with Table 3 conditions when designing.

6.1 Output voltage of standard humidity (Free from debugging) (Condition: at 25°C, Vin=5.0V) Unit: V.

Relative humidity (% RH)	0	10	20	30	40	50	60	70	80	90	100
Output voltage (V)	0	0.3	0.6	0.9	1.2	1.5	1.8	2.1	2.4	2.7	3.0

Table 5. AM1011A standard humidity output voltage response.

Full range temperature compensation, full range SCM calibration output, output impedance: less than 5 kΩ.

6.2 Relationship between humidity and output voltage

Humidity conversion formula:

$$\text{Humidity} = \text{Voltage (output Voltage)} / 0.03 \text{ (%RH)}$$

6.3 Linear relationship between the output voltage and humidity

Humidity sensor measurement range of 0-100% RH, the output voltage of 0.0-3.0 V. Voltage and humidity linear relationship is shown in Figure 6.

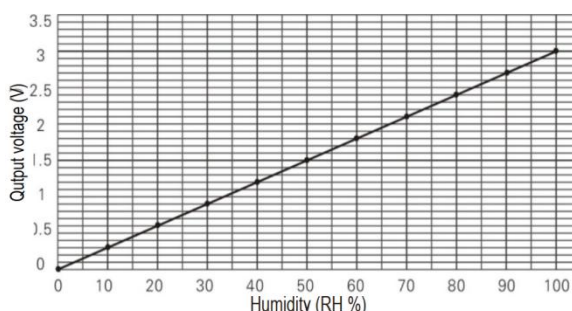

Figure 6. linear curve of the output voltage and humidity

7 Environmental stability

If a sensor is used in equipment or machinery, make sure that the sensor used for measurement and the sensor used for reference are sensing temperature and humidity under the same conditions. If the sensor is placed in the equipment, the reaction time will be prolonged, so it is necessary to ensure that sufficient measurement time is reserved in the program design. The sensor is tested according to the standard of Aosong temperature and humidity sensor enterprise. The

performance of the sensor under other test conditions is not guaranteed and cannot be considered as part of the sensor performance. For the specific occasion requested by the user, no guarantee is made.

8 Packaging

8.1 Outer Dimensions

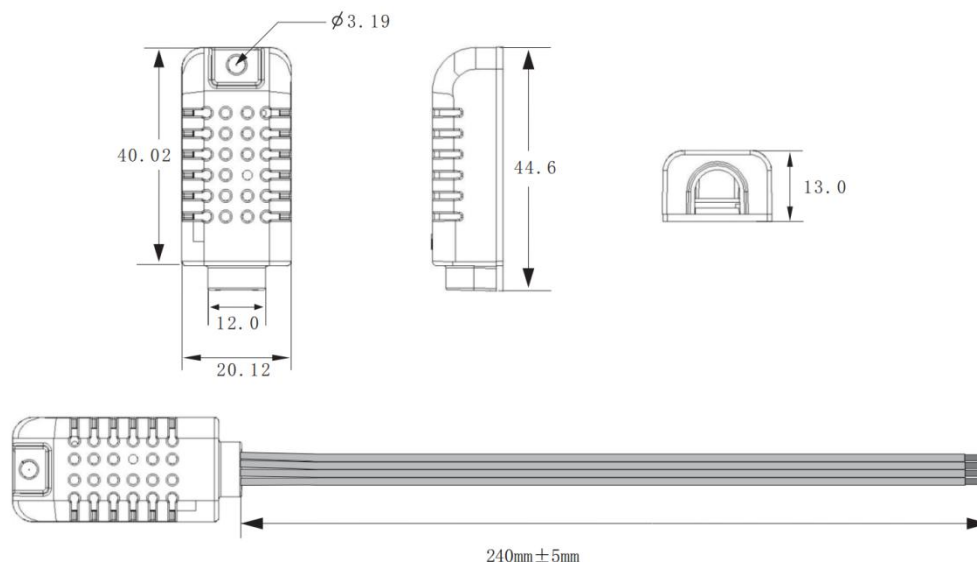

Figure 7. AM1011A sensor encapsulation (Unit: mm, Not specified tolerance: ± 0.2 mm)

8.2 Tracking information

All AM1011A sensor with laser marker on the back, as shown in Figure 8.

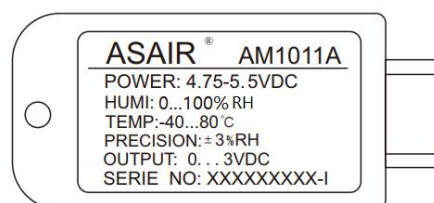

Figure 8. Laser marker on the sensor

8.3 Transportation Packing

The AM1011A is packaged in pallet style, with 25 sensors in each tray, and one empty tray is attached to each tray as a sealing cover, that is, 11 plates are sealed in a small carton with a total of 250 sensors. Each Of the four small boxes is packed in a large box, that is, each large box has 1000 sensors. A package diagram with sensor positioning is shown in Figure 8. The packing diagram of the blister tray with sensor positioning is shown in Figure 9. Blister tray is placed in carton or anti-static shielding bag.

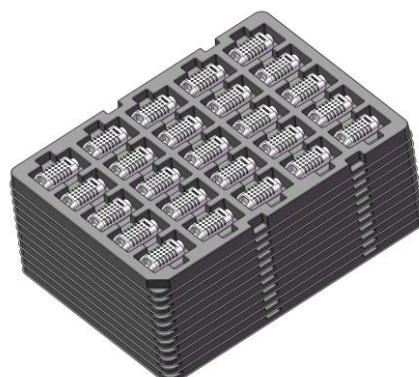
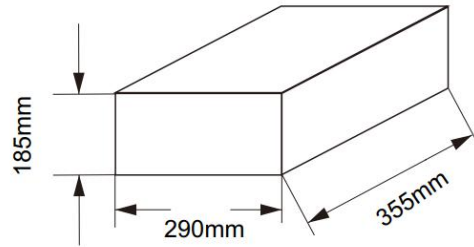
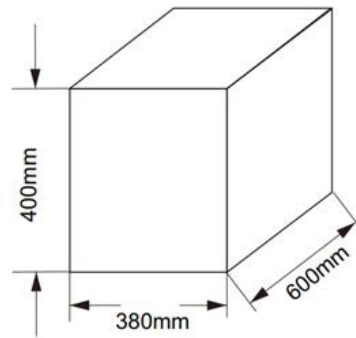

Figure 9. Package drawing with sensor positioning



Small carton size drawing:tolerance ±5mm



Size drawing of large carton:tolerance ±5mm

Anti-static bags or cartons are labeled as shown in Figure10 and provide additional tracking information.

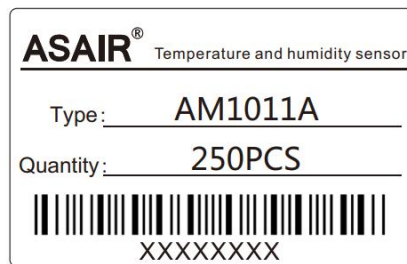

Figure 10. Label on Anti-static bag

AM1011A Packaging	Number	Total weight
One sensor	1pcs	About 13.1g
A box of sensors	250pcs	About 3.45kg
A box of sensors	1000pcs	About 15kg

NTC 10k Resistor - Temperature Characteristic Table

T(°C)	RMin(KΩ)	RNor(KΩ)	RMax(KΩ)	T(°C)	RMin(KΩ)	RNor(KΩ)	RMax(KΩ)
-40	218.9971	228.2376	237.8441	-1	28.9630	29.5745	30.1959
-39	206.2948	214.8696	223.7783	0	27.6951	28.2671	28.8480
-38	194.4226	202.3826	210.6475	1	26.4908	27.0257	27.5687
-37	183.3204	190.7126	198.3831	2	25.3463	25.8466	26.3542
-36	172.9331	179.8005	186.9219	3	24.2585	24.7264	25.2008
-35	163.2098	169.5919	176.2059	4	23.2242	23.6617	24.1051
-34	154.1034	160.0366	166.1815	5	22.2404	22.6495	23.0638
-33	145.5707	151.0884	156.7995	6	21.3044	21.6869	22.0739
-32	137.5716	142.7046	148.0144	7	20.4136	20.7711	21.1327
-31	130.0693	134.8459	139.7840	8	19.5655	19.8996	20.2373
-30	123.0294	127.4759	132.0698	9	18.7578	19.0700	19.3854
-29	116.4204	120.5608	124.8359	10	17.9884	18.2801	18.5746
-28	110.2132	114.0696	118.0492	11	17.2553	17.5276	17.8025
-27	104.3805	107.9735	111.6791	12	16.5564	16.8108	17.0673
-26	98.8973	102.2459	105.6972	13	15.8901	16.1275	16.3668
-25	93.7405	96.8620	100.0775	14	15.2547	15.4762	15.6994
-24	88.8883	91.7990	94.7955	15	14.6484	14.8550	15.0631
-23	84.3209	87.0357	89.8288	16	14.0699	14.2625	14.4564
-22	80.0197	82.5523	85.1565	17	13.5176	13.6972	13.8778
-21	75.9675	78.3306	80.7593	18	12.9903	13.1576	13.3257
-20	72.1481	74.3538	76.6191	19	12.4867	12.6425	12.7989
-19	68.5468	70.6058	72.7194	20	12.0056	12.1505	12.2960
-18	65.1498	67.0723	69.0446	21	11.5459	11.6806	11.8158
-17	61.9440	63.7394	65.5803	22	11.1064	11.2316	11.3571
-16	58.9176	60.5946	62.3132	23	10.6862	10.8025	10.9190
-15	56.0594	57.6261	59.2307	24	10.2844	10.3923	10.5002
-14	53.3589	54.8228	56.3212	25	9.9000	10.0000	10.1000
-13	50.8065	52.1745	53.5741	26	9.5249	9.6248	9.7248
-12	48.3931	49.6717	50.9791	27	9.1662	9.2658	9.3656
-11	46.1103	47.3056	48.5269	28	8.8230	8.9223	9.0218
-10	43.9502	45.0676	46.2088	29	8.4946	8.5934	8.6925
-9	41.9055	42.9503	44.0166	30	8.1803	8.2786	8.3772
-8	39.9693	40.9462	41.9428	31	7.8794	7.9770	8.0750
-7	38.1351	39.0487	39.9801	32	7.5913	7.6882	7.7855
-6	36.3970	37.2514	38.1219	33	7.3153	7.4114	7.5080
-5	34.7494	35.5484	36.3621	34	7.0509	7.1461	7.2419
-4	33.1869	33.9342	34.6949	35	6.7976	6.8919	6.9867
-3	31.7047	32.4037	33.1148	36	6.5547	6.6480	6.7420
-2	30.2982	30.9520	31.6167	37	6.3219	6.4142	6.5072

T(°C)	RMin(KΩ)	RNor(KΩ)	RMax(KΩ)	T(°C)	RMin(KΩ)	RNor(KΩ)	RMax(KΩ)
38	6.0986	6.1899	6.2818	82	1.5032	1.5469	1.5918
39	5.8845	5.9746	6.0655	83	1.4613	1.5043	1.5484
40	5.6790	5.7680	5.8578	84	1.4208	1.4630	1.5063
41	5.4818	5.5697	5.6584	85	1.3816	1.4231	1.4656
42	5.2926	5.3793	5.4669	86	1.3437	1.3844	1.4262
43	5.1109	5.1964	5.2829	87	1.3070	1.3470	1.3880
44	4.9364	5.0208	5.1060	88	1.2715	1.3107	1.3510
45	4.7688	4.8520	4.9361	89	1.2371	1.2756	1.3152
46	4.6079	4.6898	4.7727	90	1.2038	1.2416	1.2805
47	4.4532	4.5339	4.6156	91	1.1716	1.2087	1.2469
48	4.3045	4.3840	4.4645	92	1.1404	1.1768	1.2143
49	4.1616	4.2398	4.3191	93	1.1101	1.1459	1.1827
50	4.0242	4.1012	4.1793	94	1.0808	1.1159	1.1520
51	3.8920	3.9678	4.0447	95	1.0524	1.0868	1.1223
52	3.7649	3.8395	3.9152	96	1.0248	1.0587	1.0936
53	3.6426	3.7160	3.7905	97	0.9981	1.0314	1.0656
54	3.5249	3.5971	3.6704	98	0.9723	1.0049	1.0385
55	3.4116	3.4826	3.5547	99	0.9472	0.9792	1.0123
56	3.3025	3.3724	3.4433	100	0.9228	0.9543	0.9868
57	3.1975	3.2662	3.3360	101	0.8992	0.9302	0.9620
58	3.0964	3.1639	3.2325	102	0.8764	0.9067	0.9380
59	2.9990	3.0654	3.1328	103	0.8542	0.8840	0.9147
60	2.9052	2.9704	3.0367	104	0.8326	0.8619	0.8921
61	2.8148	2.8788	2.9440	105	0.8117	0.8405	0.8702
62	2.7276	2.7905	2.8547	106	0.7914	0.8197	0.8488
63	2.6436	2.7054	2.7684	107	0.7717	0.7995	0.8281
64	2.5626	2.6233	2.6853	108	0.7526	0.7799	0.8080
65	2.4845	2.5442	2.6050	109	0.7341	0.7608	0.7885
66	2.4091	2.4678	2.5276	110	0.7161	0.7423	0.7695
67	2.3365	2.3940	2.4528	111	0.6986	0.7244	0.7511
68	2.2663	2.3229	2.3806	112	0.6816	0.7069	0.7332
69	2.1987	2.2542	2.3109	113	0.6650	0.6900	0.7158
70	2.1334	2.1879	2.2436	114	0.6490	0.6735	0.6988
71	2.0703	2.1239	2.1786	115	0.6334	0.6575	0.6824
72	2.0094	2.0620	2.1158	116	0.6183	0.6419	0.6664
73	1.9506	2.0023	2.0551	117	0.6036	0.6268	0.6508
74	1.8938	1.9446	1.9964	118	0.5893	0.6121	0.6357
75	1.8390	1.8888	1.9397	119	0.5754	0.5978	0.6210
76	1.7860	1.8349	1.8849	120	0.5618	0.5839	0.6067
77	1.7348	1.7828	1.8319	121	0.5487	0.5703	0.5928
78	1.6853	1.7324	1.7807	122	0.5359	0.5572	0.5793
79	1.6374	1.6837	1.7311	123	0.5235	0.5444	0.5661
80	1.5912	1.6366	1.6831	124	0.5114	0.5319	0.5533
81	1.5464	1.5910	1.6367	125	0.4996	0.5198	0.5408

Important Notices

Warning, Personal Injury

Do not apply this product to safety protection devices or emergency stop equipment, and any other applications that may cause personal injury due to the product's failure. Do not use this product unless there is a special purpose or use authorization. Refer to the product data sheet and application guide before installing, handling, using or maintaining the product. Failure to follow this recommendation may result in death and serious personal injury.

If the buyer intends to purchase or use Aosong products without obtaining any application licenses and authorizations, the buyer will bear all the compensation for personal injury and death arising therefrom, and exempt Aosong managers and employees and affiliated subsidiaries from this. Agents, distributors, etc. may incur any claims, including: various costs, compensation fees, attorney fees, etc.

ESD Protection

Due to the inherent design of the component, it is sensitive to static electricity. In order to prevent the damage caused by static electricity or reduce the performance of the product, please take necessary anti-static measures when using this product.

Quality Assurance

The company provides a 12-month (1 year) quality guarantee (calculated from the date of shipment) to direct purchasers of its products, based on the technical specifications in the product data manual published by Aosong. If the product is proved to be defective during the warranty period, the company will provide free repair or replacement. Users need to satisfy the following conditions:

- Notify our company in writing within 14 days after the defect is found.
- The defect of this product will help to find out the deficiency in design, material and technology of our product.
- The product should be sent back to our company at the buyer's expense.
- The product should be within the warranty period.

The company is only responsible for products that are defective when used in applications that meet the technical conditions of the product. The company does not make any guarantees, guarantees or written statements about the application of its products in those special applications. At the same time, the company does not make any promises about the reliability of its products when applied to products or circuits.

This manual may be changed at any time without notice.

Copyright© 2021, ASAIR®